

PRELIMINARY REVIEW COPY

1. Report No. Preliminary Review Copy	2. Government Accession No.	3. Recipient's Catalog No.	
4. Title and Subtitle INDICATIONS ABOUT THERMAL GRADIENT MAGNITUDES FROM FIELD STUDIES OF CONCRETE BOX GIRDER BRIDGES		5. Report Date October 1998	
		6. Performing Organization Code	
7. Author(s) M. Keith Thompson, John E. Breen and Michael E. Kreger		8. Performing Organization Report No. Research Report 1820-S	
9. Performing Organization Name and Address Center for Transportation Research The University of Texas at Austin 3208 Red River, Suite 200 Austin, TX 78705-2650		10. Work Unit No. (TRAIS)	
		11. Contract or Grant No. Research Study 0-1820	
12. Sponsoring Agency Name and Address Texas Department of Transportation Research and Technology Transfer Office P.O. Box 5080 Austin, TX 78763-5080		13. Type of Report and Period Covered Summary Report (9/97-8/98)	
		14. Sponsoring Agency Code	
15. Supplementary Notes Project conducted in cooperation with the U.S. Department of Transportation			
16. Abstract Three years of continuous thermal data from three concrete box girder bridges and one concrete box girder pier are compiled into a single study. The data is used to draw conclusions about trends in thermal gradient magnitudes and shapes. The maximum gradients from the data are compared to AASHTO recommended design gradients. Statistically appropriate design gradient magnitudes are then selected from the data. Conclusions concerning the effects on thermal gradient magnitudes from cross-section shape, asphalt topping, and motor traffic are presented.			
17. Key Words		18. Distribution Statement No restrictions. This document is available to the public through the National Technical Information Service, Springfield, Virginia 22161.	
19. Security Classif. (of report) Unclassified	20. Security Classif. (of this page) Unclassified	21. No. of pages	22. Price

**Indications about Thermal Gradient Magnitudes from
Field Studies of Concrete Box Girder Bridges**

by

**M. Keith Thompson
John E. Breen
Michael E. Kreger**

Research Report Number 1820-S

Research Project 0-1820

conducted for the

Texas State Department of Transportation

in Cooperation with the

**U.S. Department of Transportation
Federal Highway Administration**

by the

**CENTER FOR TRANSPORTATION RESEARCH
BUREAU OF ENGINEERING RESEARCH
THE UNIVERSITY OF TEXAS AT AUSTIN**

October 1998

DISCLAIMERS

The contents of this report reflect the views of the authors, who are responsible for the facts and the accuracy of the data presented herein. The contents do not necessarily reflect the official views or policies of the Federal Highway Administration or the Texas Department of Transportation. This report does not constitute a standard, specification, or regulation.

There was no invention or discovery conceived or first actually reduced to practice in the course of or under this contract, including any art, method, process, machine, manufacture, design or composition of matter, or any new and useful improvement thereof, or any variety of plant which is or may be patentable under the patent laws of the United States of America or any foreign country.

NOT INTENDED FOR CONSTRUCTION,
BIDDING, OR PERMIT PURPOSES

John E. Breen, P.E. (Texas PE# 18479)

Michael E. Kreger (Texas PE# 65541)

Research Supervisor

ACKNOWLEDGMENTS

This report contains the culminated data from two TxDOT sponsored research projects, 0-1234: a field instrumentation of the San Antonio “Y,” and 0-1404: a field instrumentation of US 183 in Austin, Texas. Many University of Texas research students worked on those two projects and their efforts led directly to this report. The authors express their appreciation to Jose Arrellaga, Carin Roberts, Valerie Andres, Brian Wood, Wade Bonzon, and Rodney Davis. The authors are also very appreciative towards the Texas Department of Transportation for their continuing support of bridge related research. Pat Bachman, the TxDot project director for the San Antonio “Y” study, and Tom Rummel, the TxDot project director for the US 183 study, have been particularly helpful.

ABSTRACT

Three years of continuous thermal data from three concrete box girder bridges and one concrete box girder pier are compiled into a single study. The data is used to draw conclusions about trends in thermal gradient magnitudes and shapes. The maximum gradients from the data are compared to AASHTO recommended design gradients. Statistically appropriate design gradient magnitudes are then selected from the data. Conclusions concerning the effects on thermal gradient magnitudes from cross-section shape, asphalt topping, and motor traffic are presented.

IMPLEMENTATION

This report documents measurements from field studies of three concrete box girder bridges and one concrete box girder pier. Based on examination of thermal data from these four structures, conclusions concerning the effects of cross-section shape, asphalt topping, and motor traffic on thermal gradient magnitudes are made. Statistically appropriate design gradient magnitudes are then selected from the data from which future design gradients can be based.

Table of Contents

CHAPTER 1: INTRODUCTION.....	1
1.1 Content of Report.....	1
1.2 Project 0-1234: “Instrumentation of Segmental Box Girder Bridges and Multi-Piece Winged Boxes”.....	1
1.3 Project 0-1404: “Instrumentation of Precast Segmental Box Girder Bridges on US 183 in Austin”.....	2
CHAPTER 2: THERMAL GRADIENTS.....	5
2.1 Data Presentation.....	5
2.1.1 San Antonio “Y” Span A44.....	5
2.1.2 US 183 Mainlane Span D6.....	6
2.1.3 US 183 Ramp P.....	8
2.1.4 US 183 Large Ramp Pier P16.....	9
2.2 Comparison and Discussion of Data.....	10
2.2.1 Positive Gradient Shapes.....	10
2.2.2 Negative Gradient Shapes.....	12
2.2.3 Occurrence of Maximum Gradients.....	13
2.3 Conclusions.....	17
2.4 Recommendations.....	18
CHAPTER 3: LONG-TERM STRAIN GAUGE DATA.....	19
REFERENCES.....	21

List of Figures

Figure 1. 1: Project 0-1234 field instrumentation locations (San Antonio, TX)	2
Figure 1. 2: Project 0-1404 field instrumentation locations (Austin, TX).....	3
Figure 2. 1: Cross-section and instrumentation for Span A44 of the San Antonio “Y”	5
Figure 2. 2: San Antonio “Y” daily maximum gradient data.	6
Figure 2. 3: Cross-section and instrumentation for Span D6 of the US 183 Mainlane.	7
Figure 2. 4: US 183 Mainlane daily maximum gradient data.....	7
Figure 2. 5: Cross-section and instrumentation for US 183 Ramp P.....	8
Figure 2. 6: US 183 Ramp P daily maximum gradient data.	8
Figure 2. 7: Cross-section and instrumentation for US 183 Pier P16.....	9
Figure 2. 8: US 183 Pier P16 daily peak gradient data.	10
Figure 2. 9: Maximum positive gradient shapes.....	11
Figure 2. 10: Maximum negative gradient shapes.	12
Figure 2. 11: Probability of positive gradients in superstructure before traffic.....	14
Figure 2. 12: Probability of positive gradients in superstructure after traffic.....	14
Figure 2. 13: Probability of positive gradients in substructure.....	15
Figure 2. 14: Probability of negative gradients in superstructure before asphalt.	16
Figure 2. 15: Probability of negative gradients in superstructure after asphalt.	16
Figure 2. 16: Probability of negative gradients in substructure.....	17
Figure 3. 1: Concrete strain gauge performance in US 183 Ramp P.....	19
Figure 3. 2: External tendon strain gauge performance in Ramp P.	20

List of Tables

Table 2.1: Thermal gradient data information.....	13
---	----

CHAPTER 1

INTRODUCTION

1.1 CONTENT OF REPORT

At the conclusion of project 0-1404: *Instrumentation of Precast Segmental Box Girder Bridges on US 183 in Austin*, much of the data collection was left incomplete. Collection of strain data related to long-term performance of the bridges and temperature data concerning thermal gradient magnitudes had only been ongoing for a few months in some of the instrumented structures when the time allotted for the project ran out. In order that the study could be completed properly, a new project, project 0-1820: *Long Term Monitoring of the Precast Segmental Balanced Cantilever Ramp on US 183 in Austin*, was initiated to continue the data collection from the instruments in US 183 for an additional year. This report presents the data that has been collected through August of 1998 (the termination period for project 0-1820) as well as conclusions and recommendations that were not previously contained in the 0-1404 reports [1, 2, 3].

Most of the material in this report will discuss thermal gradients. In addition to the data which has been collected from US 183, three years of thermal gradient data was also available from instrumentation of the San Antonio "Y" (project 0-1234: *Instrumentation of Segmental Box Girder Bridges and Multi-Piece Winged Boxes*). After the termination of project 0-1234, data retrieval from San Antonio was continued by researchers on the US 183 study. Eventually the equipment left in the San Antonio "Y" was dismantled and recycled in the US 183 research. However, three years of data was collected before that time. Only the first year of this data was presented in the 0-1234 reports (CTR 0-1234-3F: *Measurement Based Revisions for Segmental Bridge Design and Construction Criteria* [4]). This present report condenses the thermal gradient data from both studies in its investigation of design magnitudes for thermal gradients. This material is presented in Chapter 2.

Aside from the study of thermal gradients, long-term changes in the bridge structures were examined. Deterioration of the strain gauges in the project made collection of good long-term strain data impossible. This problem is discussed briefly in Chapter 3 of this report.

Projects 0-1404 and 0-1234 are briefly discussed in this introductory chapter in order to refresh the reader in the history of the instrumentation studies that lead to the data in this report.

1.2 PROJECT 0-1234: "INSTRUMENTATION OF SEGMENTAL BOX GIRDER BRIDGES AND MULTI-PIECE WINGED BOXES"

Project 0-1234 was conducted from mid-1990 through late 1993. It involved development and implementation of instrumentation devices for the study of segmental concrete box girder bridges. Implementation of the methods developed early in the study was carried out in several spans of the San Antonio "Y" bridges that were erected during the time span of the research project. Project 0-1234 had the following research goals:

1. Identify the various design uncertainties and areas where verifications of assumptions are necessary in segmental box girders.

2. Study available instrumentation devices and systems in order to select appropriate methods for the study and instrumentation of an actual box girder bridge.
3. Evaluate the candidate instrumentation systems under laboratory and field conditions.
4. Implement the instrumentation in selected spans of an actual bridge in order to obtain desired information about the bridge's behavior.
5. Interpret the field measurements and derive meaningful conclusions about the bridge's behavior.
6. Develop proposed changes to the *AASHTO Interim Design and Construction Provisions for Segmental Box Girder Construction* [5].

Data collected from this study led to design recommendations concerning such topics as losses in external post-tensioning tendons, stress distributions in box girders, thermal gradients in box girders, segmental joints, discontinuity zone behavior, behavior under construction and live loads of segmental box girder bridges, and temperature induced deformations in match cast segments. Roberts presented the results of the study in CTR 0-1234-3F [4]. Figure 1.1 shows the location of the 0-1234 field studies (instrumented spans are shaded gray).

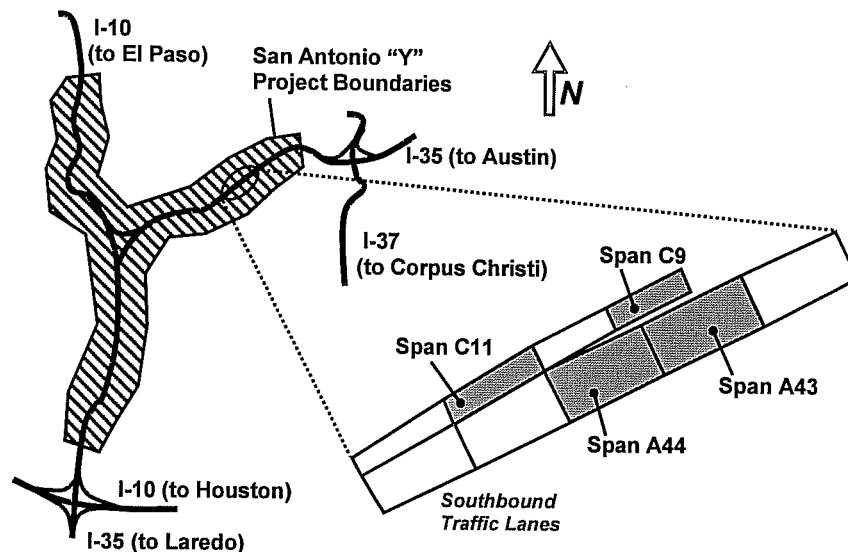

Figure 1.1: Project 0-1234 field instrumentation locations (San Antonio, TX).

1.3 PROJECT 0-1404: "INSTRUMENTATION OF PRECAST SEGMENTAL BOX GIRDER BRIDGES ON US 183 IN AUSTIN"

Project 0-1404 was conducted from the late 1993 through early 1997. It continued the studies that had begun with project 0-1234 with the instrumentation of another segmental box girder bridge, US 183 in Austin, Texas. This time, substructure elements were studied as well as superstructure elements. Many of the same topics that had been studied in the San

Antonio “Y” were also studied in US 183. The project contained many of the same goals as project 0-1234. Data collected from US 183 included losses in external post-tensioning tendons, stress distributions in box girders, thermal gradients in box girders, discontinuity zone behavior, behavior under construction and live loads of segmental box girder bridges, behavior of segmental piers, and behavior of an innovative “Y”-shaped pier. This data has lead to many design recommendations on these topics. CTR reports 0-1404-1 through 0-1404-3F discuss the project in much greater detail [1, 2, 3]. Figure 1.2 shows the location of the 0-1404 field studies (instrumented regions are shaded in gray). Project 0-1820 continued the study of Ramp P shown in the lower right in Figure 1.2.

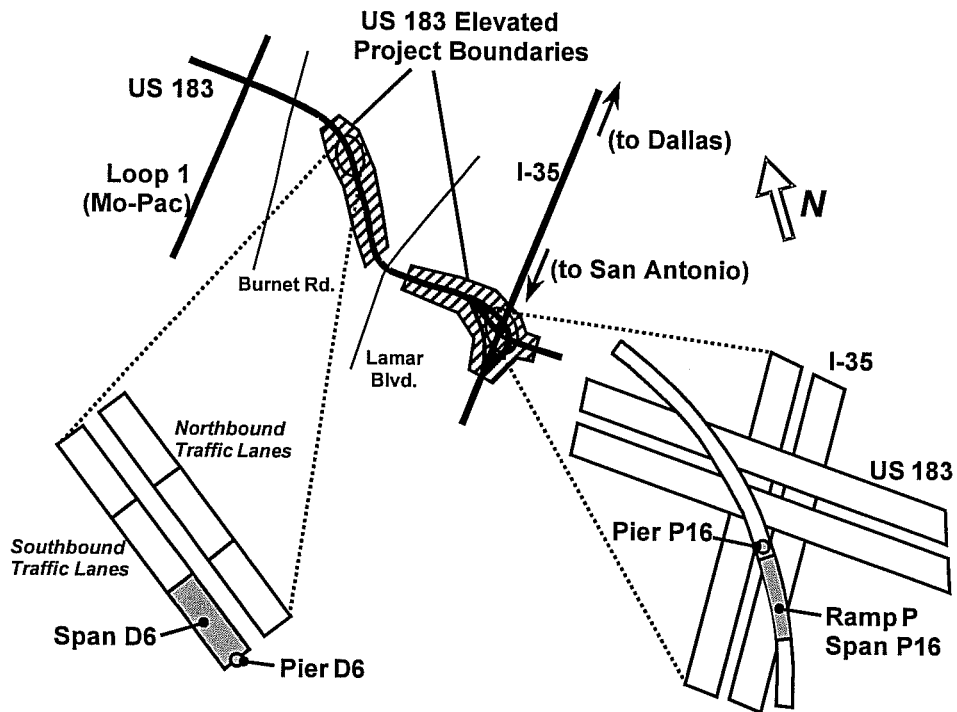

Figure 1.2: Project 0-1404 field instrumentation locations (Austin, TX).

CHAPTER 2

THERMAL GRADIENTS

2.1 DATA PRESENTATION

This chapter presents daily thermal gradient data from one span in the superstructure of the San Antonio "Y," one mainlane span and one balanced cantilever ramp span in the superstructure of US 183 elevated highway, and one hollow box pier in the US 183 substructure. For purposes of simplification, thermal gradients are frequently referred to by their peak gradient magnitude, neglecting any information about the shape of the gradient. In all discussions within this report, the magnitude of a positive thermal gradient is measured by the temperature difference between the topmost thermocouple (usually 25mm (1") beneath the surface of the bridge deck) and the lowest temperature reading through the depth of the cross-section (typically somewhere within the webs of the box girder). Negative thermal gradient magnitudes are measured by the temperature difference between the topmost thermocouple and the highest temperature reading through the depth of the cross-section.

2.1.1 San Antonio "Y" Span A44

Seven thermocouples were monitored in Span A44 of the San Antonio "Y" from August 8, 1992, through November 15, 1995. Figure 2.1 shows the thermocouple arrangement and the cross-sectional dimensions of the span. The top and bottom thermocouples were located 25mm (1") from the surface of the concrete. All dimensions are in millimeters.

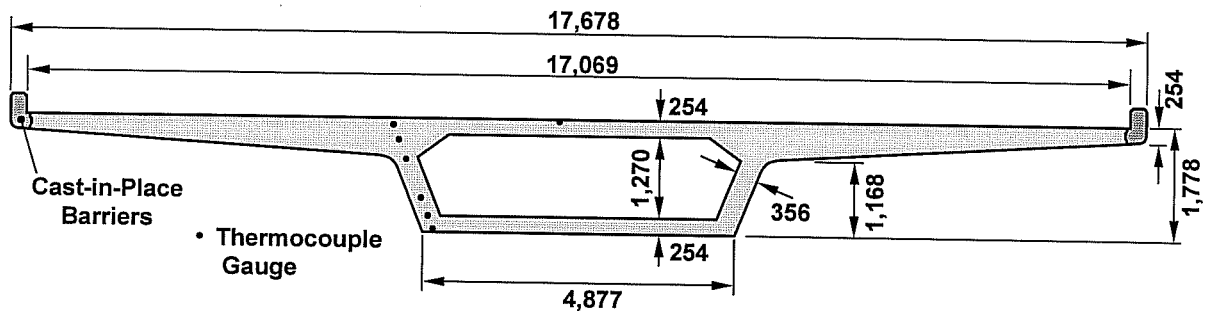

Figure 2.1: Cross-section and instrumentation for Span A44 of the San Antonio "Y."

Figure 2.2 shows the maximum positive and negative gradient magnitudes from each day that data was available. Roberts reported that a 50mm (2") asphalt topping was placed on the deck of the bridge by March 25, 1993 [4]. An exact date was not available, but it is believed that the bridge was opened to traffic in early June of 1993. There are 863 days of complete data for positive and negative gradients.

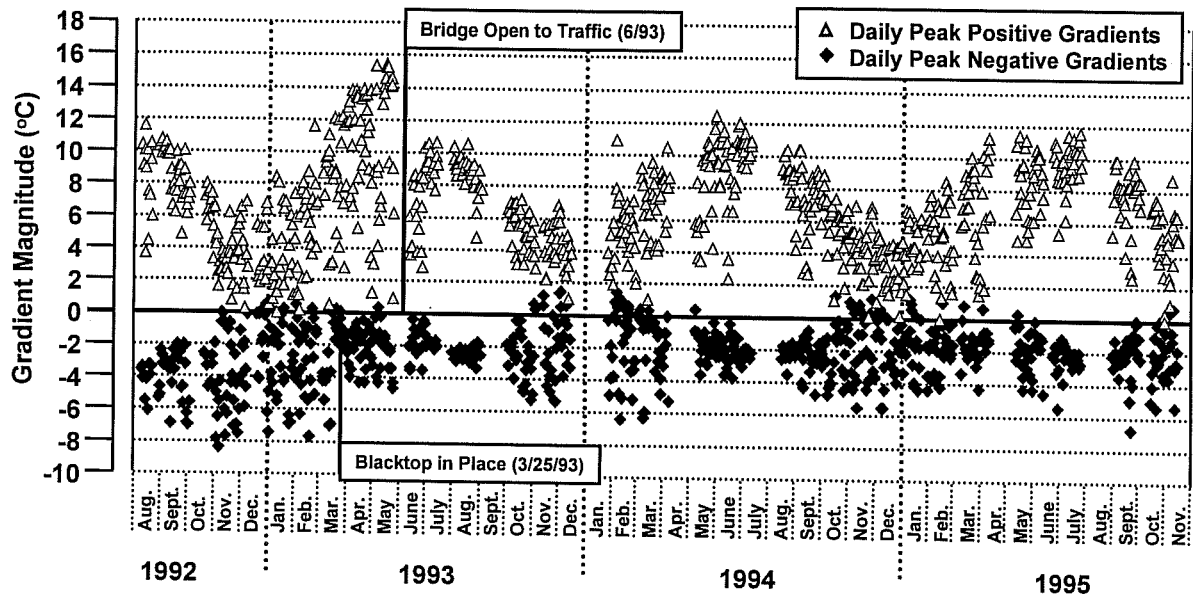

Figure 2.2: San Antonio "Y" daily maximum gradient data.

Two trends are noticed in the data. First, peak negative gradients after application of the asphalt topping were only about 75% of the magnitude of peak negative gradients before application of the asphalt topping. Second, peak positive gradients after the opening of the bridge to traffic are only about 80% of the magnitude of peak positive gradients before the bridge was opened to traffic. The design gradient specifications provided in the *AASHTO LRFD Bridge Design Specifications (1994 Edition)* [6] indicate a reduction in gradient magnitude after asphalt is placed on the bridge. However, the data from San Antonio indicates that the highest positive gradients occurred after the asphalt was placed, but before the bridge had opened to traffic. Succeeding summers with the asphalt in place had lower positive gradients (Summer is the season that generally produces the highest positive gradients). This trend suggests that reduction in positive gradient magnitudes is better attributed to the opening of the bridge to traffic rather than the application of an asphalt topping. Maximum negative gradients are caused by sudden cooling of the deck of the bridge from cold fronts or precipitation. Asphalt insulates the concrete against sudden temperature changes and causes a reduction in the magnitudes of negative gradients. In contrast, maximum positive gradients are caused by steady heating of the bridge deck and are not dependent on sudden temperature changes. Thus, the insulating nature of the asphalt topping has less effect. It has previously been suggested that traffic causes a reduction in peak gradient magnitudes. Hawkins and Clark concluded from the data in their 1982 study of the Denny Creek Bridge in Washington State that traffic reduced thermal gradients by stirring surface air on the deck of the bridge [7]. This certainly appears true from the measurements in Figure 2.2.

2.1.2 US 183 Mainlane Span D6

Thirty-three thermocouples were monitored in mainlane Span D6 of US 183 in Austin, Texas from March 23, 1995, through August 30, 1998. Figure 2.3 shows the thermocouple arrangement and the cross-sectional dimensions of the span. The top and bottom thermocouples were located 25mm (1") from the surface of the concrete. All dimensions are

in millimeters. Note that the US 183 mainlane has very similar dimensions to the San Antonio “Y” except for the depth of the box and the thickness of the webs. This difference is because US 183 had longer span lengths than the San Antonio “Y” and needed greater shear and moment capacity in the bridge cross-section.

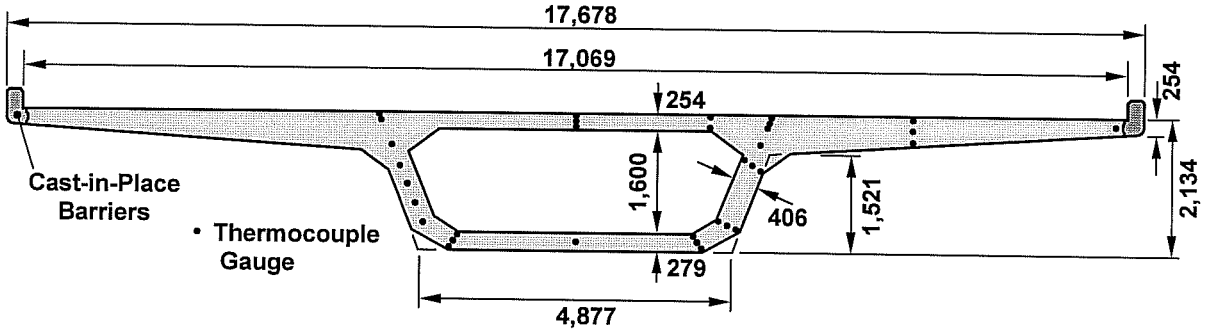

Figure 2.3: Cross-section and instrumentation for Span D6 of the US 183 Mainlane.

The US 183 mainlane data was examined in the same manner as the San Antonio “Y” data. Figure 2.4 shows the maximum positive and negative gradients from each day that data was available. There are 1,009 days of complete data for positive and negative gradients. Additionally, the same trends that were noted in the San Antonio “Y” data were also noted here. Further evidence that the asphalt topping did not affect the magnitude of the positive gradients is provided by comparing the summer before the asphalt was applied to the summer just after the asphalt was applied. Both time periods have roughly the same magnitudes of maximum positive gradients though during the latter summer the bridge deck had a 50mm (2") asphalt covering. Again, the opening of the bridge to traffic with consequent stirring of the air on the deck results in substantially reduced gradients (20% to 25% smaller).

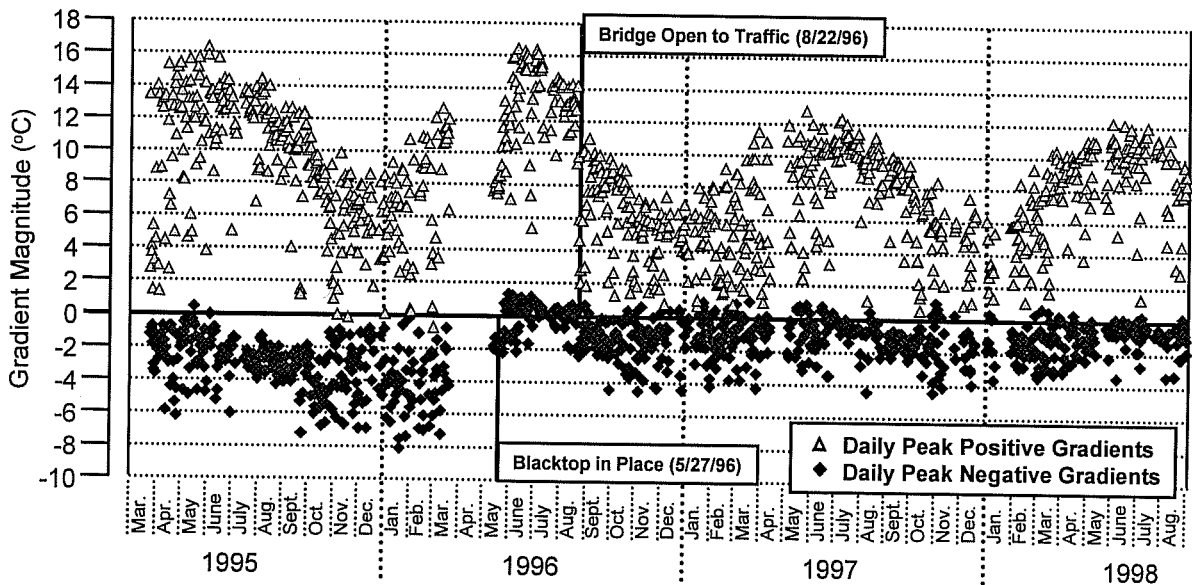

Figure 2.4: US 183 Mainlane daily maximum gradient data.

2.1.3 US 183 Ramp P

Fifty-four thermocouples were monitored in US 183 Ramp P from November 1, 1996, through August 30, 1998. Figure 2.5 shows the arrangement of the thermocouples and the cross-section dimensions of the bridge. Note that Ramp P has much smaller proportions than either of the two previously instrumented bridge sections. The top and bottom thermocouples were placed 25mm (1") beneath the surface of the concrete. All dimensions are in millimeters.

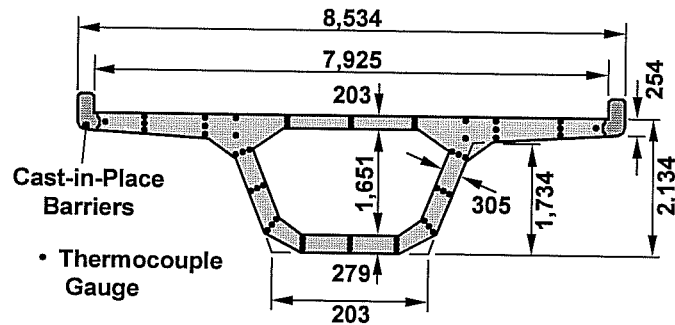

Figure 2.5: Cross-section and instrumentation for US 183 Ramp P.

Figure 2.6 shows the maximum positive and negative gradients from each day that data was available. There are 492 days of complete data. Because there is less data for Ramp P, trends are not as evident in this plot as for the previous two bridges. However, one can see that there is a noticeable reduction in negative gradient magnitude after the asphalt is placed on the bridge deck. Except for a single "outlier" point, which has been associated with the spraying of hot asphalt on the bridge deck, the most severe positive gradients in this bridge were much less than the 16°C magnitude generally seen in the two previous bridges. This fact is probably due to differences in the proportions of the bridge cross-sections (The effect of cross-section proportioning on gradient shape will be discussed in sections 2.2.1 and 2.2.2). Again, positive gradient magnitudes were reduced somewhat (between 10% to 15%) after the bridge was opened to traffic.

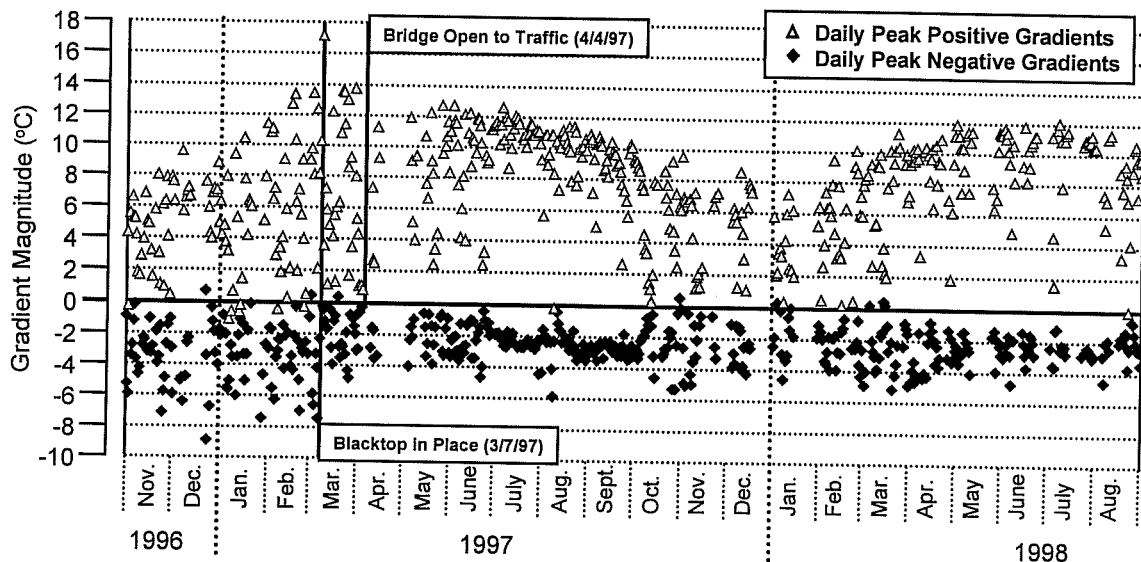

Figure 2.6: US 183 Ramp P daily maximum gradient data.

2.1.4 US 183 Large Ramp Pier P16

Twenty-four thermocouples were monitored in one of the tallest piers, Pier P16, in the US 183 project. Figure 2.7 show the location of the instrumentation and the pier cross-section. The instrumentation was located at a height along the pier that was generally unshaded by the superstructure or any other surrounding structures. Principal sunlight exposure was on the east and west faces of the pier and the thermocouples along that axis were used to measure the thermal gradients in the pier. Outer and inner thermocouples were located 25mm (1") beneath the concrete surface. Dimensions are in millimeters except where noted. Positive and negative thermal gradients were measured as the temperature difference between the outermost thermocouples and the innermost ones.

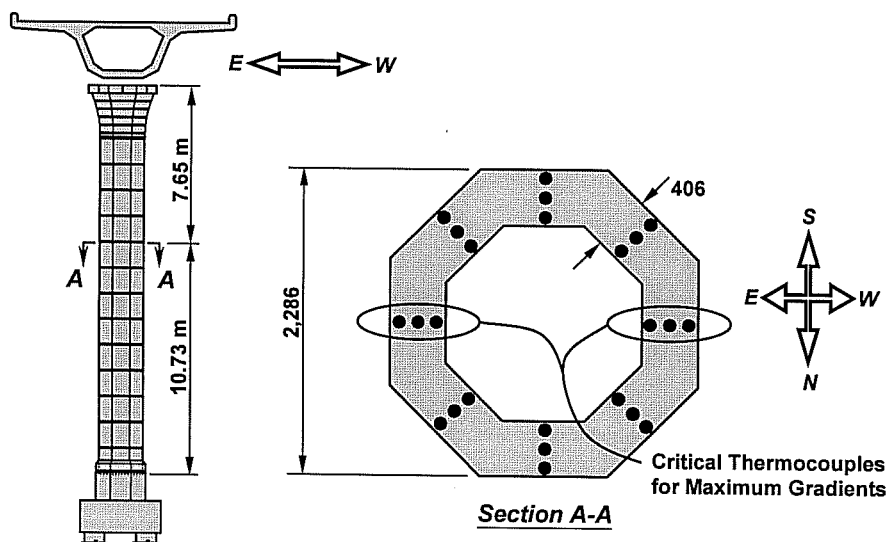

Figure 2.7: Cross-section and instrumentation for US 183 Pier P16.

Figure 2.8 shows the maximum positive and negative thermal gradients from each day of available data. The dates when the superstructure was being erected in balanced cantilever are indicated in the figure. There was no major effect on thermal gradient magnitudes from placement of the superstructure, which provided little shade at the instrumented location. Unlike the superstructure, the most severe positive gradients occurred in the winter months. The maximum positive gradients were about the same magnitude as those seen in the superstructures of the San Antonio "Y" and the US 183 Mainlane, but the maximum negative gradients were more severe than had been seen in any of the superstructures.

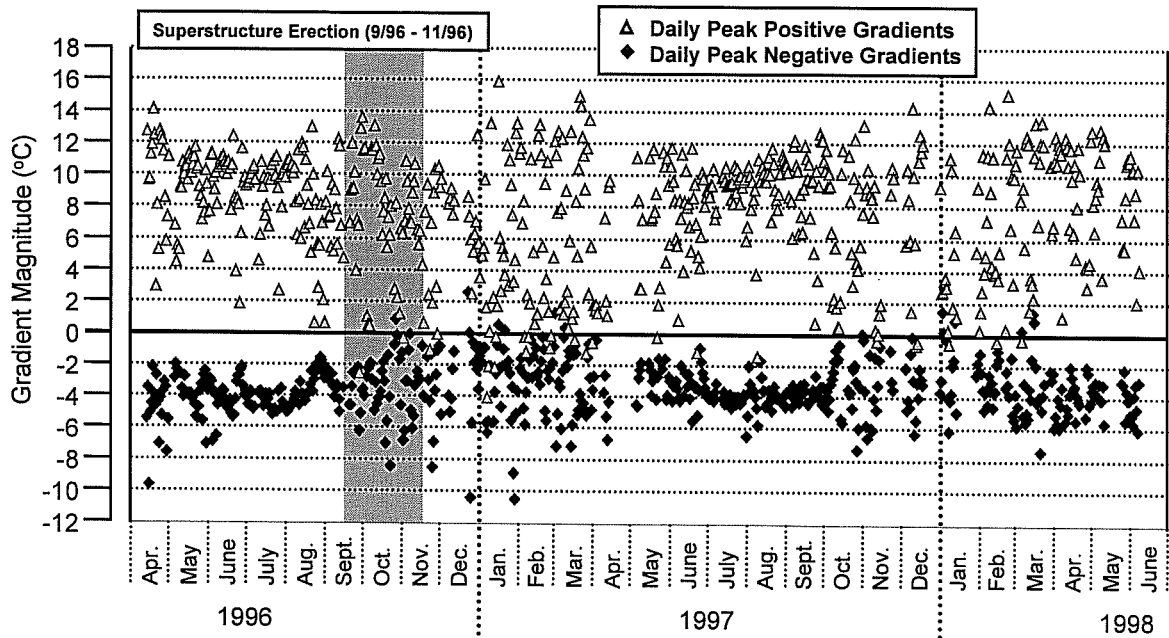

Figure 2.8: US 183 Pier P16 daily peak gradient data.

2.2 COMPARISON AND DISCUSSION OF DATA

2.2.1 Positive Gradient Shapes

Figure 2.9 shows the relative proportions of the different cross-sections and the maximum measured positive gradients that occurred in each structure. The gradient shape presented for each superstructure cross-section is averaged across the width of the section. The peak gradients in each superstructure all occurred at 5:00 pm in the late afternoon. The temperature value at the surface of the concrete was linearly extrapolated from the data. The extrapolated magnitude is presented in italics next to each gradient. Typically, the extrapolated surface temperature was 10% to 13% higher than the measured temperature 1" beneath the surface. Thus, the actual magnitude of the gradients are estimated to be 10% to 13% higher than the values derived from direct measurements by the thermocouples.

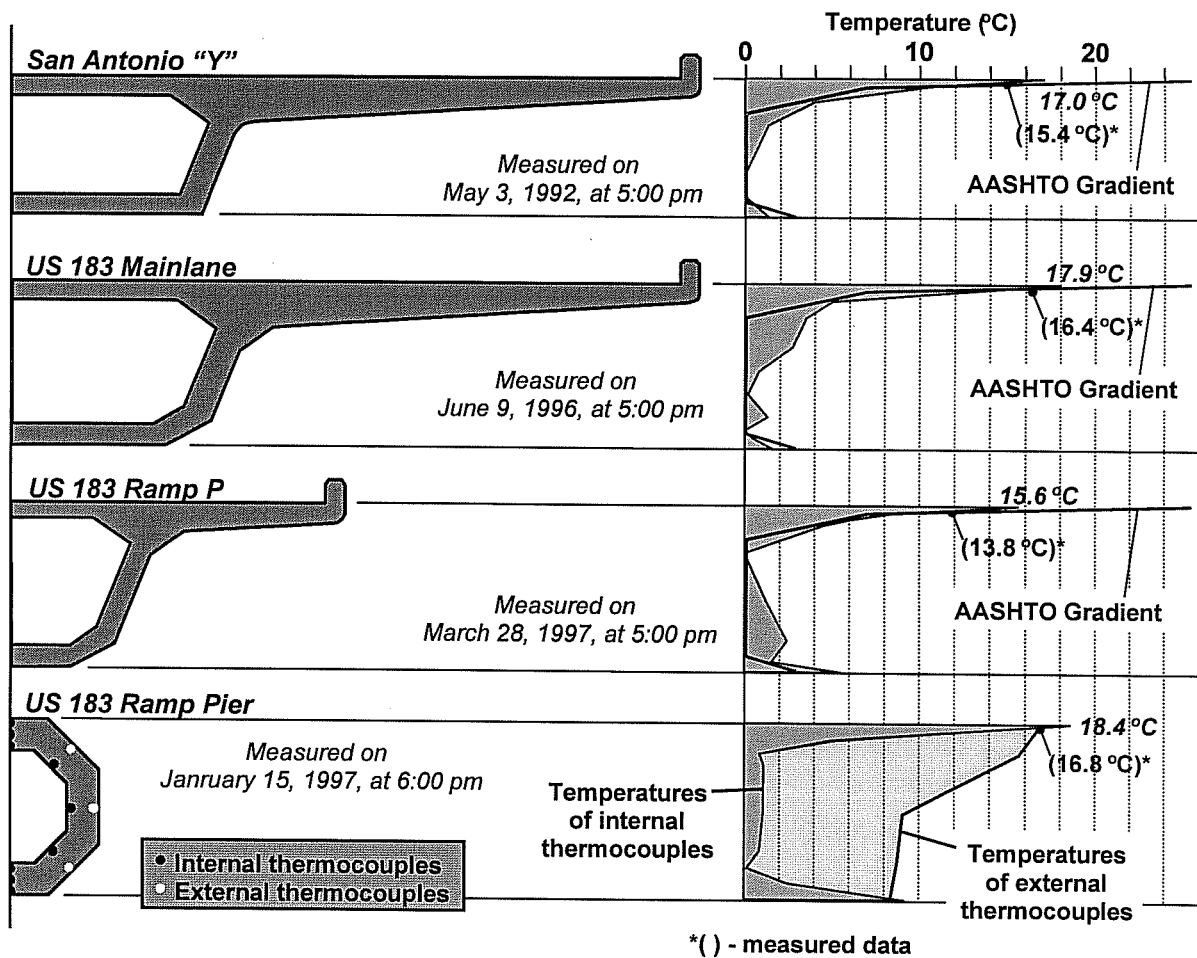

Figure 2.9: Maximum positive gradient shapes.

The San Antonio "Y" and US 183 Mainlane had very similar gradient shapes and magnitudes. This is not surprising since the proportions of the two box girders are similar. The elevated temperatures of each of those gradients extends deep into the web of the cross-section. However, US 183 Ramp P had a maximum positive gradient with a 10% smaller magnitude that extended far less into the web. The difference between the shapes of these gradients may be due to the difference in the widths of the deck compared to the width of the webs. The deck is the primary surface through which the cross-section absorbs heat. That heat is transmitted into the rest of the cross-section through the webs. The relative proportioning of the webs to the deck would be an important influence in the development of the temperature distribution in the cross-section.

The AASHTO design gradient for Zone 2 with a plain concrete surface is presented next to the superstructure gradients (*AASHTO LRFD Specifications, 1994 ed.* [6]). None of the superstructure gradients reach more than about 75% of the magnitude (60% for Ramp P) of the design gradient (25.6°C). Furthermore, the temperature of the webs is not zero as is indicated by the AASHTO gradient shape.

The gradient shape for the US 183 Ramp Pier contains two lines of data. The gradient temperatures along the interior of the box pier wall and along the exterior of the box pier wall

are both presented. The difference between these two lines of data shows that a large gradient is present from the inside to the outside of the pier wall. A thermal gradient does exist from one side of the pier to the other. After averaging across the width of the pier, this gradient would be less in magnitude than the gradients that were seen in the superstructures.

2.2.2 Negative Gradient Shapes

Figure 2.10 shows relative proportions of the different cross-sections and the maximum negative gradients that occurred in each structure. The peak negative gradients for the superstructures all occurred in the morning at 7:00 or 8:00 am. The temperature value at the surface of the concrete was linearly extrapolated from the data. The extrapolated magnitude is presented in italics next to each gradient. Typically, the extrapolated surface temperature was 10% to 17% lower than the measured temperature 1" beneath the surface. Thus, the actual magnitude of the gradients are estimated to be 10% to 17% higher than the values derived from direct measures of the thermocouples.

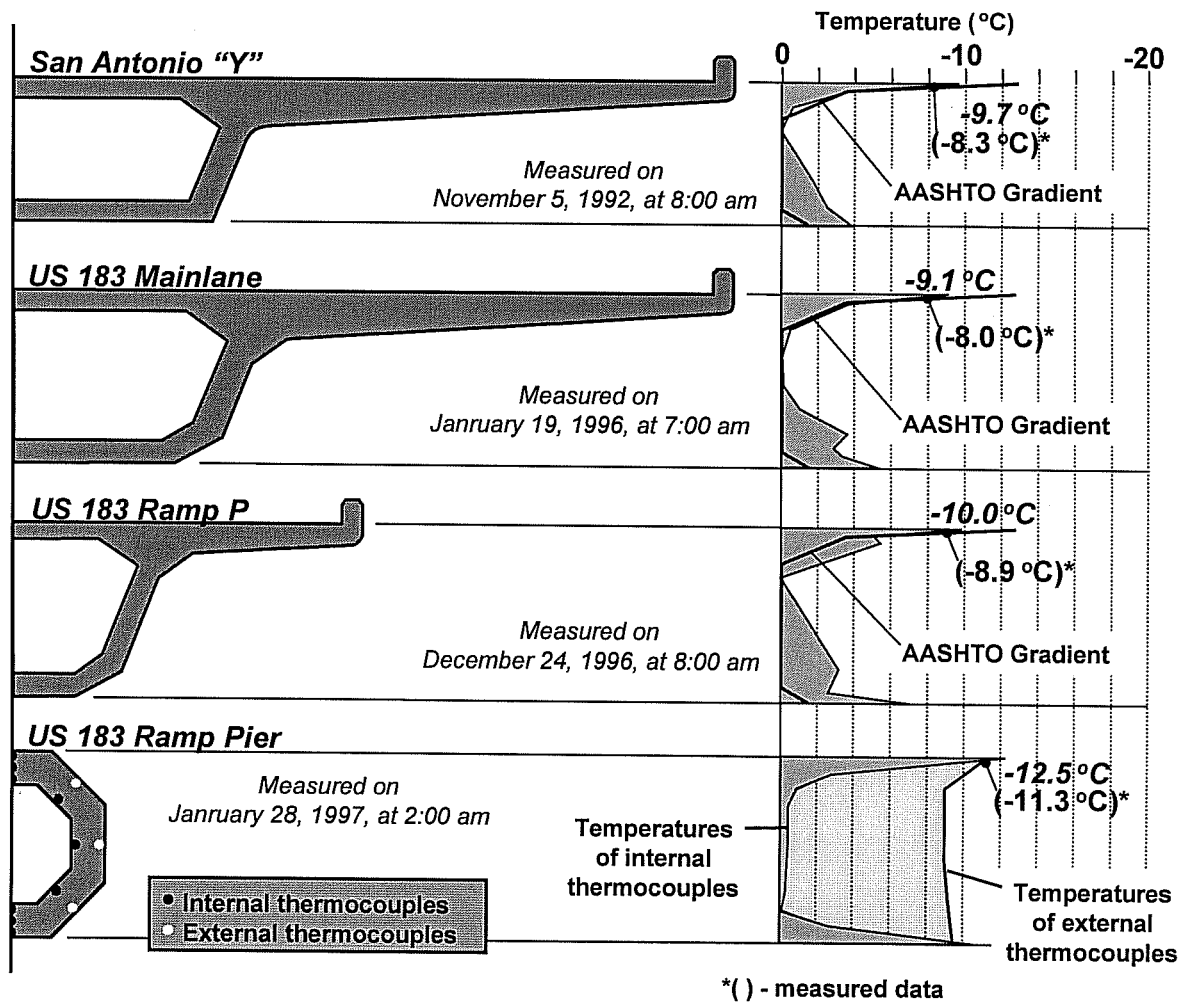

Figure 2.10: Maximum negative gradient shapes.

All three superstructures had similar negative gradient shapes and magnitudes. The magnitudes of these gradients on the average were 25% less than the magnitude of the

AASHTO LRFD design gradient (The Zone 2 plain concrete surface negative design gradient has a magnitude of -12.8°C) [6]. The top portion of each superstructure gradient was generally matched by the design gradient. However, the portion of the gradients through the webs and bottom flange was not well matched by the design gradient.

Once again, temperature values along the inside and outside of the pier wall are presented. The shapes indicate that there was no resultant negative gradient of significance across the width of the pier. However, there is a large gradient from the inside to the outside of the pier wall.

2.2.3 Occurrence of Maximum Gradients

The data collected from the different bridge structures was tabulated and counted to determine the statistical probabilities that an extreme gradient would occur on a given day. For the superstructure sections, the positive gradient data was split into two groups: before motor traffic began on the bridge and after. The negative gradient data was split into two groups before and after the application of asphalt. The numbers of points and dates of availability for the data are listed in Table 2.1.

Table 2.1: Thermal gradient data information.

Type of Data	Measured in Which Structure	Number of Points	Dates of Data
Positive Gradients (no surface traffic)	San Antonio "Y"	247	08/08/92 – 05/24/93
	US 183 Mainlane	421	03/23/95 – 08/21/96
	US 183 Ramp P	128	10/29/96 – 04/03/97
Positive Gradients (with surface traffic)	San Antonio "Y"	616	06/11/93 – 11/15/93
	US 183 Mainlane	588	08/22/96 – 08/30/98
	US 183 Ramp P	364	04/09/97 – 08/30/98
Negative Gradients (no asphalt overlay)	San Antonio "Y"	187	08/08/92 – 03/25/93
	US 183 Mainlane	325	03/23/95 – 03/18/96
	US 183 Ramp P	101	10/29/96 – 03/6/97
Negative Gradients (with asphalt overlay)	San Antonio "Y"	676	03/26/93 – 11/15/95
	US 183 Mainlane	684	05/11/96 – 08/30/98
	US 183 Ramp P	391	03/08/97 – 08/30/98
Substructure Gradients (negative & positive)	US 183 Ramp Pier	628	04/13/96 – 06/07/98

Figures 2.11, 2.12, and 2.13 present plots that show the probability that a positive gradient of a given magnitude or greater occurred on a given day in each of the different instrumented structures. For some of the structures, on particularly cold days, positive gradients did not occur during the course of the day. Thus, some of the plots do not show 100% probability that a positive gradient with a magnitude greater than 0°C will occur on a given day (i.e., They do not intersect the vertical axis at 100%).

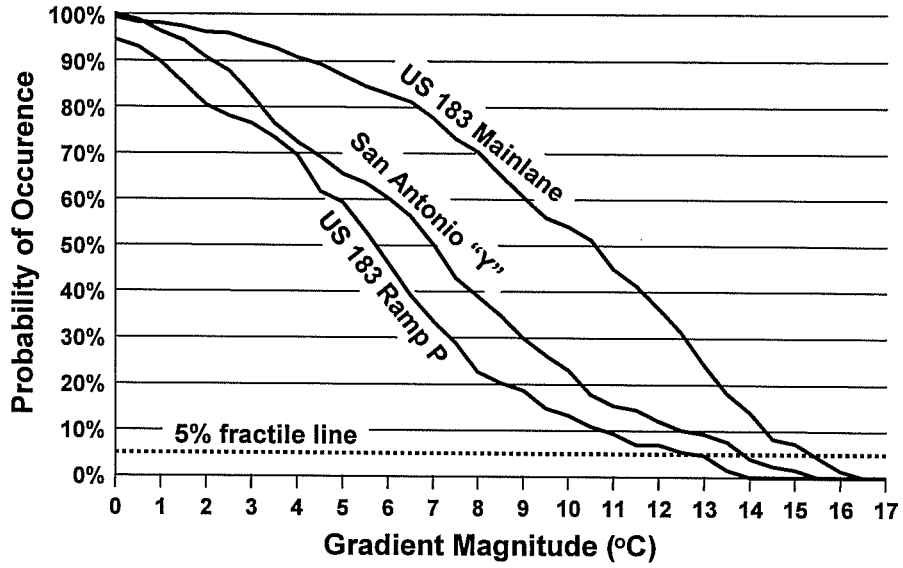

Figure 2.11: Probability of positive gradients in superstructure before traffic.

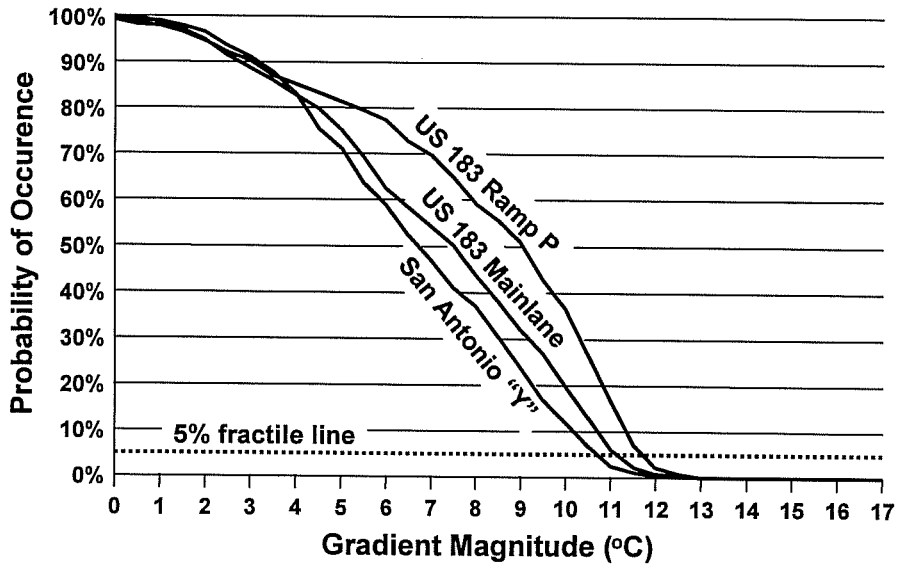

Figure 2.12: Probability of positive gradients in superstructure after traffic.

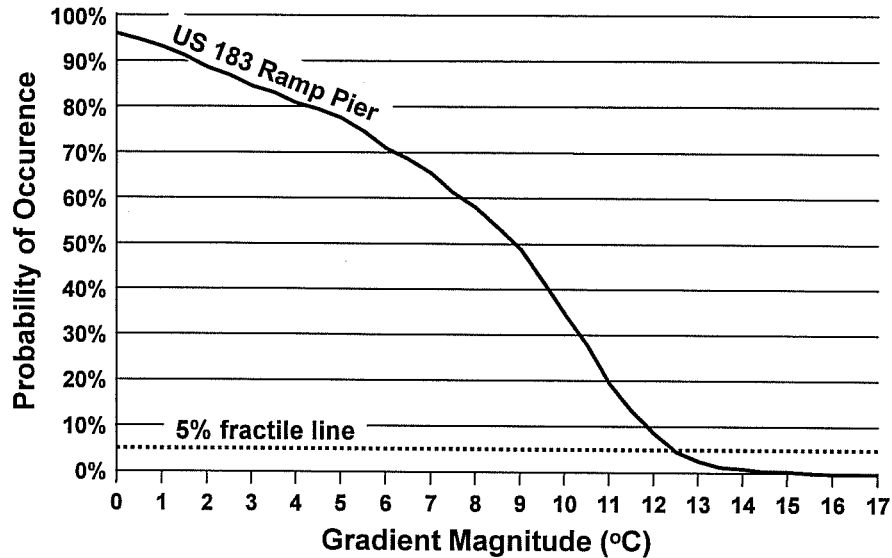

Figure 2.13: Probability of positive gradients in substructure.

The gradients that coincide with a 5% probability of occurrence are the values that are of interest in the plots. Selection of these gradients as design gradients will provide a 95% confidence that an appropriate gradient is used. The highest recorded gradient is not an appropriate design gradient because it occurs too infrequently. Rather, a lower magnitude gradient with a more frequent rate of occurrence should be chosen for practicality. A 95% confidence level is consistent with other statistically determined design loads (i.e., wind gusts, water loads, etc.). Thus, the gradients that coincide with a 5% probability of occurrence (the 5% fractile) are recommended for design purposes. The probability plots presented in this section are intended for the selection of appropriate design gradient magnitudes. The temperature values for the plots are based upon the measured data (the thermocouple temperature values measured 1" into the surface of the concrete), not the extrapolated temperatures at the surface of the concrete. In accordance with the observations presented in the previous two sections dealing with gradient shapes, the estimated magnitudes of the actual gradients (measured to the surface of the concrete) are between 10% to 17% higher than the measured magnitudes.

From Figures 2.11 through 2.13, the 5% fractile gradients are 15.5°C for positive gradients without traffic, 12.0°C for positive gradients after traffic, and 12.5°C for positive gradients in hollow box pier substructures. These values should be increased by 15% to account for the difference between measured and actual gradients (giving magnitudes of 17.8°C, 13.8°C, and 14.4°C respectively).

Figures 2.14 through 2.16 present plots that show the probability that a negative gradient of a given magnitude or greater occurred on a given day in each of the different instrumented structures. From these figures, the 5% fractile gradients are -6.7°C for negative gradients without asphalt, -4.5°C for positive gradients with 50mm (2") asphalt topping, and -6.0°C for positive gradients in hollow box pier substructures. These values should be increased by 15% to account for the difference between measured and actual gradients (giving 7.7°C, 5.2°C, and 6.9°C respectively).

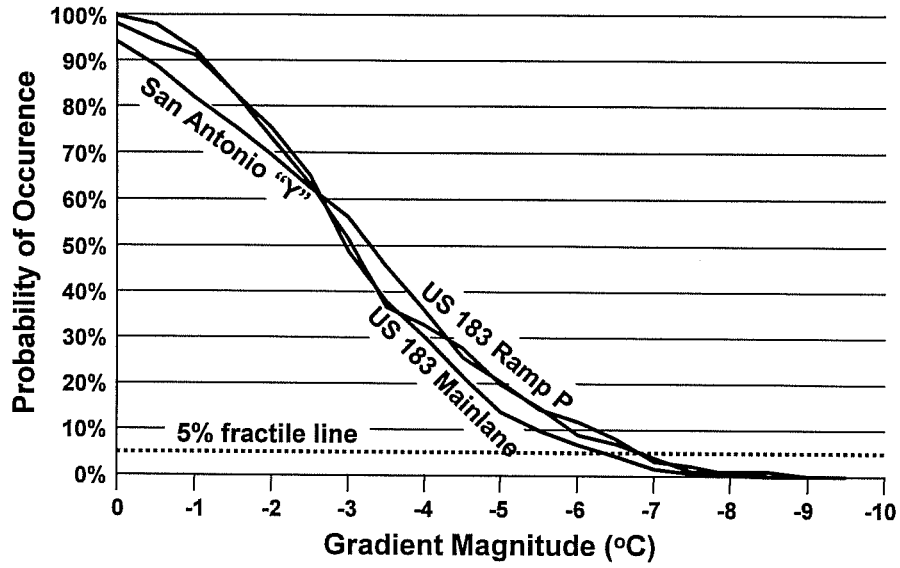

Figure 2.14: Probability of negative gradients in superstructure before asphalt.

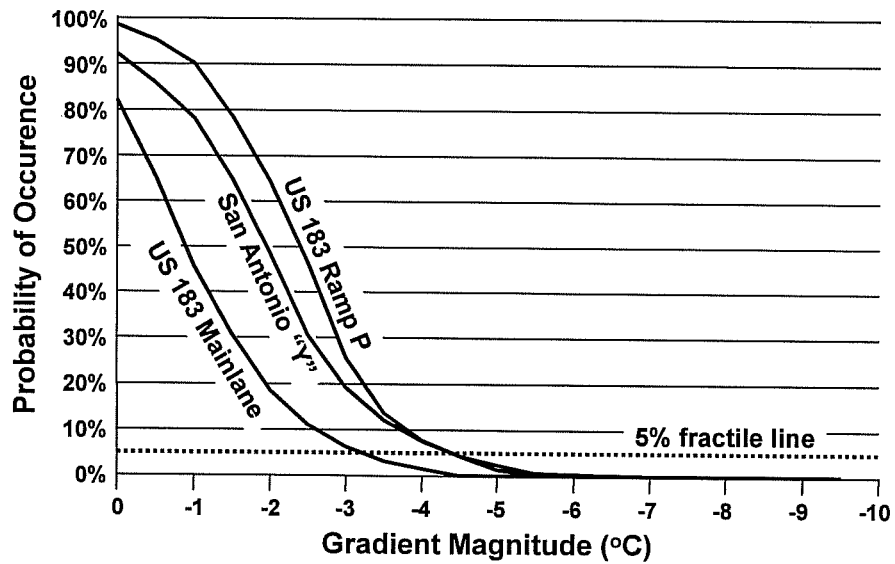

Figure 2.15: Probability of negative gradients in superstructure after asphalt.

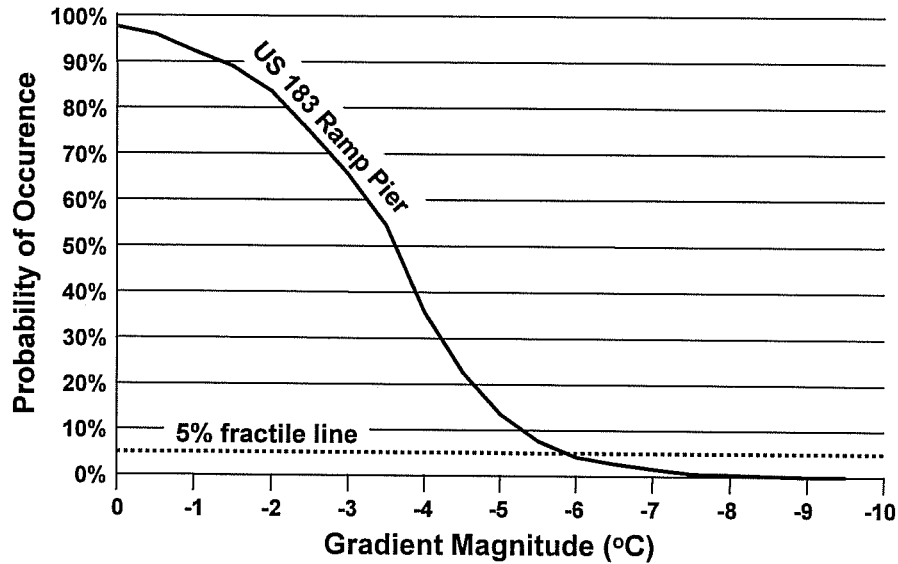

Figure 2.16: Probability of negative gradients in substructure.

2.3 CONCLUSIONS

The following conclusions have been made from the data:

- 1) Positive gradient magnitudes were not reduced by the application of 50mm (2") of asphalt topping. Instead, the passing of regular vehicle traffic on the bridge deck caused a 20% reduction in positive gradient magnitudes.
- 2) Negative gradients were reduced by 25% when 50mm (2") of asphalt topping was placed on the deck. The passing of regular vehicle traffic caused no significant changes in negative gradient magnitudes.
- 3) Thermal gradients through the width of the hollow box pier substructure were small. However, thermal gradients through the thickness of the pier wall (from the inside to the outside of the pier) were significant.
- 4) Similarities in size and proportions of the San Antonio "Y" cross-section and the US 183 Mainlane cross-section caused these two bridges to have positive gradients of similar shapes and magnitudes. US 183 Ramp P had a cross-section of much smaller proportions than the other two bridges. The difference in proportions caused the ramp to have positive gradients that varied in shape and magnitude from the other two bridges. These differences occurred despite the fact that all three bridges are located in similar climates. From this observation it is concluded that bridges of different cross-sections can experience different thermal gradient conditions from each other despite exposure to similar climatic conditions. Further study is necessary to determine if this effect is significant or can be ignored so that specification of one design gradient shape and magnitude for each climate zone is valid.
- 5) The shapes and magnitudes of the observed positive and negative gradients were not well fit by the recommended AASHTO design gradients. The current

recommended design gradients are larger than what has been observed in the Texas studies.

- 6) The occurrence of the maximum thermal gradients was infrequent. Design gradients should reflect more statistically recurrent gradients. Gradients that are concurrent with a 95% confidence level using methods of statistical reduction similar to the methods used in these studies are suggested.

2.4 RECOMMENDATIONS

Recent studies of the behavior of box girder bridges under the actions of nonlinear thermal gradients (see Thompson [2] and Davis [3]) have shown that the AASHTO recommended method for analysis of thermal gradient actions provides unrealistic and sometimes unconservative stress results. Comparisons between measured stresses and calculated design stresses indicated that actual stresses could exceed design values even when the measured thermal gradients were less severe than the design gradients used for the calculations. The data presented in this report could be used to recommend design gradients that better reflected the thermal gradients that have been measured in box girder bridges than the current AASHTO gradients. However, such recommendations are withheld from this report until the behavior of these types of bridges is better understood.

CHAPTER 3

LONG-TERM STRAIN GAUGE DATA

Originally it was hoped that the concrete strain gauges placed in the US 183 structures could be used to provide information on long-term creep and shrinkage effects in the bridges. However, analysis of the data over the past year has shown that the significant degeneration of these gauges after the bridges opened to traffic has rendered them useless for long-term and even short-term strain change readings. Figure 3.1 shows the output of four top flange concrete gauges in segment P16-17 of US 183 Ramp P. This segment is near the mid-span of a 54.8m (180') span (see Thompson [2] for more information on the location of instrumentation in US 183 Ramp P).

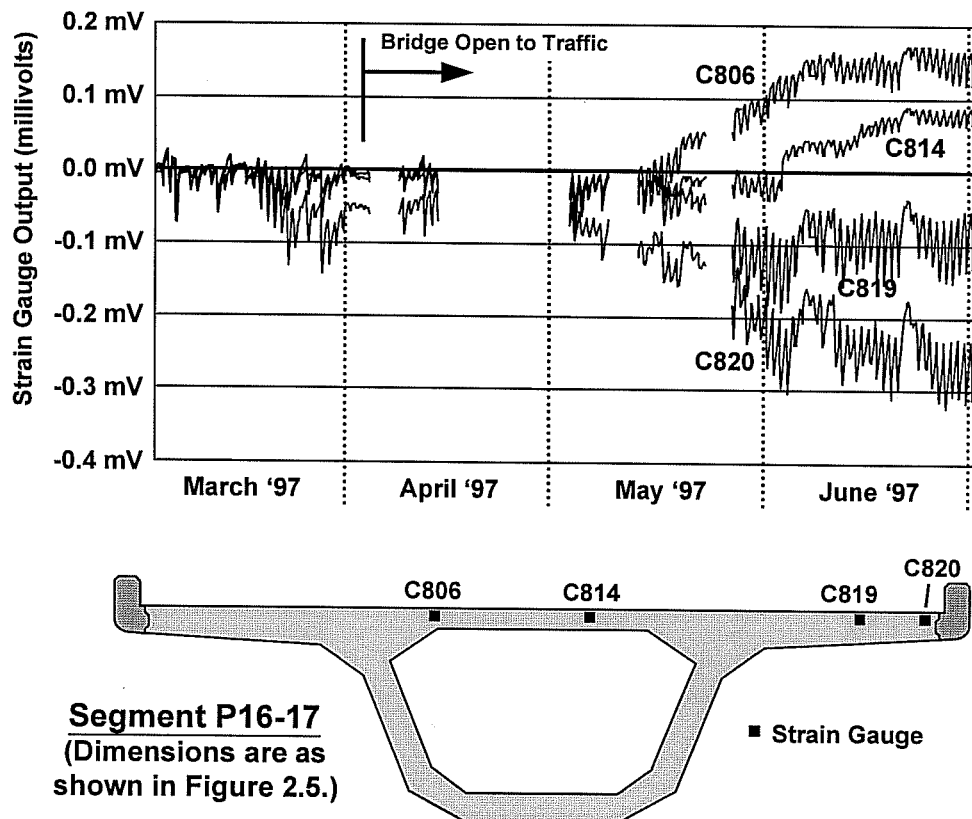

Figure 3.1: Concrete strain gauge performance in US 183 Ramp P.

There are gaps in the data from this time period due to data retrieval problems that are unrelated to the strain gauge output. The figure shows that in mid-May, the gauge output began to drift into unreliable output levels. Furthermore, the behavior of each of these four gauges was inconsistent. Some of the gauges tended towards increasing negative output and some towards increasing positive output. The behavior of the gauges cannot be interpreted to be a consistent trend in the top flange strain. This behavior was typical of all the strain gauges in Ramp P, even for the gauges on the external tendons. Figure 3.2 shows the behavior of four external tendon strain gauges in the same span.

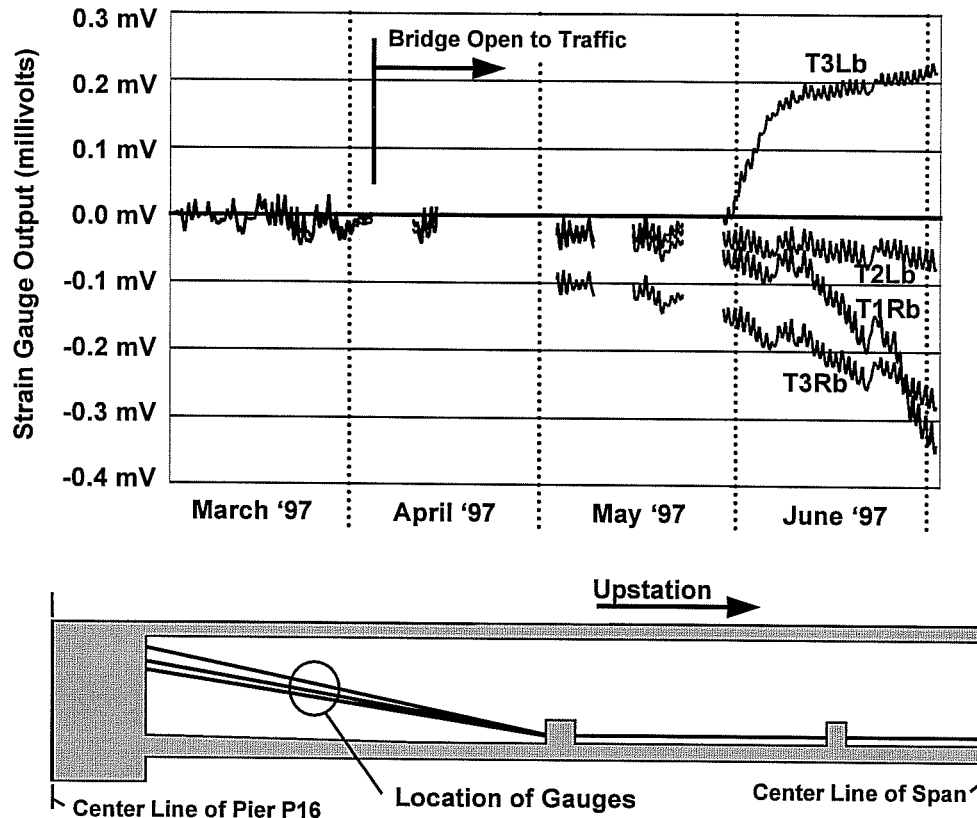

Figure 3.2: External tendon strain gauge performance in Ramp P.

Because the degeneration of the strain gauges began after the bridge was opened to traffic, it is believed that recurrent heavy truck loads may have caused the gauges to fatigue beyond their measurement capacity. A static live load test of the bridge with dump trucks showed very low stresses (see Thompson [2]). However, many of the trucks which currently pass over the bridge are typically more heavily loaded than the dump trucks used in the live load test and they produce much larger forces due to dynamic effects. Researchers who have gone inside the box girder to retrieve data have observed noticeable movement of the structure from the traffic passing on the deck.

As previously discussed in Chapter 2, the most severe thermal gradients already occurred in the bridge before asphalt was placed on the deck and before it became open to traffic. Sufficient thermal data has been collected to draw conclusions about the statistical frequency of gradients. Furthermore, the degeneration of the strain gauges has rendered them useless for long term information about structural behavior. Thus, since there is no more need for temperature or strain data collection, it is recommended that the retrievable data collection equipment be removed from the US 183 structures and be recycled into other research studies.

REFERENCES

- [1] Andres, V.A., Bonzon, W.S., Davis, R.T., Breen, J.E., and Kreger, M.E., "Measured Behavior and Thermal Gradients in Innovative Bridge Piers," Center for Transportation Research Report 0-1404-1, The University of Texas at Austin, May 1998.
- [2] Thompson, M.K., Davis, R.T., Breen, J.E., and Kreger, M.E., "Measured Behavior of a Curved Precast Segmental Concrete Bridge Erected by Balanced Cantilevering," Center for Transportation Research Report 0-1404-2, The University of Texas at Austin, January 1998.
- [3] Davis, R.T., Thompson, M.K., Breen, J.E., and Kreger, M.E., "Measurement Based Performance Evaluation of a Segmental Concrete Bridge," Center for Transportation Research Report 0-1404-3F, The University of Texas at Austin, September 1998.
- [4] Roberts, C.L., Breen, J.E., and Kreger, M.E., "Measurement Based Revisions for Segmental Bridge Design and Construction Criteria," Center for Transportation Research Report 0-1234-3F, The University of Texas at Austin, August 1993.
- [5] American Association of State Highway and Transportation Officials (AASHTO), *Guide Specifications for Design and Construction of Segmental Concrete Bridges*, 1994 Interim Specifications, AASHTO, Washington, D.C., 1994.
- [6] American Association of State Highway and Transportation Officials (AASHTO), *AASHTO LRFD Bridge Design Specifications: Customary US Units*, 1st ed., AASHTO, Washington, D.C., 1994.
- [7] Hawkins, N.M. and Clark, J.H., "Investigation of Thermal and Live Load Stresses in Denny Creek Viaduct," Report No. WA-RD 58.1, University of Washington, June 1983.