

1. Report No. FHWA/TX-93+1265-1		2. Government Accession No.		3. Recipient's Catalog No.	
4. Title and Subtitle Studies on Damage and Corrosion Performance of Fabricated Epoxy-coated Reinforcement				5. Report Date January 1993	
				6. Performing Organization Code	
7. Author(s) K. Z. Kahhaleh, H. Y. Chao, J. O. Jirsa, R. L. Carrasquillo, and H. G. Wheat				8. Performing Organization Report No.	
9. Performing Organization Name and Address Center for Transportation Research The University of Texas at Austin Austin, Texas 78712-1075				10. Work Unit No. (TR AIS)	
				11. Contract or Grant No. Research Study 3-5-91/3-1265	
12. Sponsoring Agency Name and Address Texas Department of Transportation Transportation Planning Division P. O. Box 5051 Austin, Texas 78763-5051				13. Type of Report and Period Covered Interim	
				14. Sponsoring Agency Code	
15. Supplementary Notes Study conducted in cooperation with the U.S. Department of Transportation, Federal Highway Administration. Research study title: "Structural Integrity of Epoxy-coated Bars"					
16. Abstract  The various sources and consequences of damage to epoxy-coated reinforcement were studied. For inspection of damage before placement, holiday detectors were evaluated. Potential damage, resulting from concreting operations such as placement and consolidation, was investigated. To examine the quality of the coating following application, a hot water bath test was evaluated. Finally, corrosion performance of the epoxy-coated reinforcement was evaluated by cyclic immersion of bars with different damage levels in a saltwater solution. Based on the findings, recommendations are provided for modifying current inspection, fabrication, patching, and placement procedures.					
17. Key Words Damage, placement, epoxy-coated reinforcement, consolidation, holiday detectors, immersion, cyclic, patching, inspection, saltwater solution, corrosion			18. Distribution Statement No restrictions. This document is available to the public through the National Technical Information Service, Springfield, Virginia 22161.		
19. Security Classif. (of this report) Unclassified		20. Security Classif. (of this page) Unclassified		21. No. of Pages 80	22. Price

1. Report No. FHWA/TX-93+1265-1		2. Government Accession No.		3. Recipient's Catalog No.	
4. Title and Subtitle Studies on Damage and Corrosion Performance of Fabricated Epoxy-coated Reinforcement				5. Report Date January 1993	
				6. Performing Organization Code	
7. Author(s) K. Z. Kahhaleh, H. Y. Chao, J. O. Jirsa, R. L. Carrasquillo, and H. G. Wheat				8. Performing Organization Report No.	
9. Performing Organization Name and Address Center for Transportation Research The University of Texas at Austin Austin, Texas 78712-1075				10. Work Unit No. (TR AIS)	
				11. Contract or Grant No. Research Study 3-5-91/3-1265	
				13. Type of Report and Period Covered Interim	
12. Sponsoring Agency Name and Address Texas Department of Transportation Transportation Planning Division P. O. Box 5051 Austin, Texas 78763-5051				14. Sponsoring Agency Code	
15. Supplementary Notes Study conducted in cooperation with the U.S. Department of Transportation, Federal Highway Administration. Research study title: "Structural Integrity of Epoxy-coated Bars"					
16. Abstract  The various sources and consequences of damage to epoxy-coated reinforcement were studied. For inspection of damage before placement, holiday detectors were evaluated. Potential damage, resulting from concreting operations such as placement and consolidation, was investigated. To examine the quality of the coating following application, a hot water bath test was evaluated. Finally, corrosion performance of the epoxy-coated reinforcement was evaluated by cyclic immersion of bars with different damage levels in a saltwater solution. Based on the findings, recommendations are provided for modifying current inspection, fabrication, patching, and placement procedures.					
17. Key Words Damage, placement, epoxy-coated reinforcement, consolidation, holiday detectors, immersion, cyclic, patching, inspection, saltwater solution, corrosion				18. Distribution Statement No restrictions. This document is available to the public through the National Technical Information Service, Springfield, Virginia 22161.	
19. Security Classif. (of this report) Unclassified		20. Security Classif. (of this page) Unclassified		21. No. of Pages 80	22. Price

**STUDIES ON DAMAGE AND CORROSION PERFORMANCE OF  
FABRICATED EPOXY-COATED REINFORCEMENT**

by

K. Z. Kahhaleh, H. Y. Chao, J. O. Jirsa,  
R. L. Carrasquillo, and H. G. Wheat

**Research Report 1265-1**

Structural Integrity of Epoxy-coated Bars  
Research Project 3-5-91/3-1265

conducted for the

**Texas Department of Transportation**  
and the  
**U.S. Department of Transportation**  
**Federal Highway Administration**

by the

**CENTER FOR TRANSPORTATION RESEARCH**  
**Bureau of Engineering Research**  
**THE UNIVERSITY OF TEXAS AT AUSTIN**

January 1993

Prepared in cooperation with the Texas Department of Transportation and the  
U.S. Department of Transportation.

### **DISCLAIMERS**

The contents of this report reflect the views of the authors, who are responsible for the facts and the accuracy of the data presented herein. The contents do not necessarily reflect the official views or policies of the Federal Highway Administration or the Texas Department of Transportation. This report does not constitute a standard, specification, or regulation.

**NOT INTENDED FOR CONSTRUCTION,  
BIDDING, OR PERMIT PURPOSES.**

J. O. Jirsa, P.E. (Texas No. 29859)  
R. L. Carrasquillo, P.E. (Texas No. 63881 )  
*Research Supervisors*



## PREFACE

This is the first report on a project to evaluate the structural integrity of epoxy-coated reinforcing bars used in transportation structures in the state of Texas. The report describes an investigation aimed to evaluate some inspection techniques such as holiday detection and to determine damage to epoxy-coated reinforcement during fabrication and concrete vibration. The relative corrosion performance of bent bars damaged to various degrees and subjected to a corrosive environment was also studied. The research was conducted at the Phil M. Ferguson Structural Engineering Laboratory as part of the research program of the Center for Transportation Research at The University of Texas at Austin. The work was sponsored jointly by the Texas Department of Transportation and the Federal Highway Administration.

Liaison with the Texas Department of Transportation was maintained through the contact representatives, Mr. Lloyd Wolf, the project's technical panel chairman, and Mr. Robert Sarcinella, who provided information regarding use of epoxy-coated bars in Department projects. Mr. Peter Chang is the contact representative for the Federal Highway Administration.

The study was conducted under the supervision of J.O. Jirsa, R.L. Carrasquillo, and H.G. Wheat. The majority of the experimental work presented herein formed the basis for a Master of Science thesis by Mr. H.Y. Chao. The technical review, interpretation of the results, and preparation of the final manuscript were done by Mr. K.Z. Kahhaleh, who is a Ph.D. candidate and research assistant on the project. The major portion of the experimental program, and the evaluation of the performance of epoxy-coated bars under conditions which simulate the corrosive environment and structural conditions in which coated bars are typically used, is still in progress. Additional reports on the tests continuing will be reported in the future.

The authors would like to express their gratitude for the assistance and cooperation of all the staff of the Phil M. Ferguson Structural Engineering Laboratory. Special thanks are expressed to Sharon Cunningham, who helped in the preparation of the drawings, and to Joy Bradford, who typed and edited the manuscript.

# METRIC (SI\*) CONVERSION FACTORS

## APPROXIMATE CONVERSIONS TO SI UNITS

Symbol	When You Know	Multiply by	To Find	Symbol
<b>LENGTH</b>				
in	inches	2.54	centimeters	cm
ft	feet	0.3048	meters	m
yd	yards	0.914	meters	m
mi	miles	1.61	kilometers	km
<b>AREA</b>				
in <sup>2</sup>	square inches	645.2	millimeters squared	mm <sup>2</sup>
ft <sup>2</sup>	square feet	0.0929	meters squared	m <sup>2</sup>
yd <sup>2</sup>	square yards	0.836	meters squared	m <sup>2</sup>
mi <sup>2</sup>	square miles	2.59	kilometers squared	km <sup>2</sup>
ac	acres	0.395	hectares	ha
<b>MASS (weight)</b>				
oz	ounces	28.35	grams	g
lb	pounds	0.454	kilograms	kg
T	short tons (2,000 lb)	0.907	megagrams	Mg
<b>VOLUME</b>				
fl oz	fluid ounces	29.57	milliliters	mL
gal	gallons	3.785	liters	L
ft <sup>3</sup>	cubic feet	0.0328	meters cubed	m <sup>3</sup>
yd <sup>3</sup>	cubic yards	0.0765	meters cubed	m <sup>3</sup>

NOTE: Volumes greater than 1,000 L shall be shown in m<sup>3</sup>.

## APPROXIMATE CONVERSIONS FROM SI UNITS

Symbol	When You Know	Multiply by	To Find	Symbol
<b>LENGTH</b>				
mm	millimeters	0.039	inches	in
m	meters	3.28	feet	ft
m	meters	1.09	yards	yd
km	kilometers	0.621	miles	mi
<b>AREA</b>				
mm <sup>2</sup>	millimeters squared	0.0016	square inches	in <sup>2</sup>
m <sup>2</sup>	meters squared	10.764	square feet	ft <sup>2</sup>
m <sup>2</sup>	meters squared	1.20	square yards	yd <sup>2</sup>
km <sup>2</sup>	kilometers squared	0.39	square miles	mi <sup>2</sup>
ha	hectares (10,000 m <sup>2</sup> )	2.53	acres	ac
<b>MASS (weight)</b>				
g	grams	0.0353	ounces	oz
kg	kilograms	2.205	pounds	lb
Mg	megagrams (1,000 kg)	1.103	short tons	T
<b>VOLUME</b>				
mL	milliliters	0.034	fluid ounces	fl oz
L	liters	0.264	gallons	gal
m <sup>3</sup>	meters cubed	35.315	cubic feet	ft <sup>3</sup>
m <sup>3</sup>	meters cubed	1.308	cubic yards	yd <sup>3</sup>
<b>TEMPERATURE (exact)</b>				
°C	Celsius temperature	9/5 (then add 32)	Fahrenheit temperature	°F

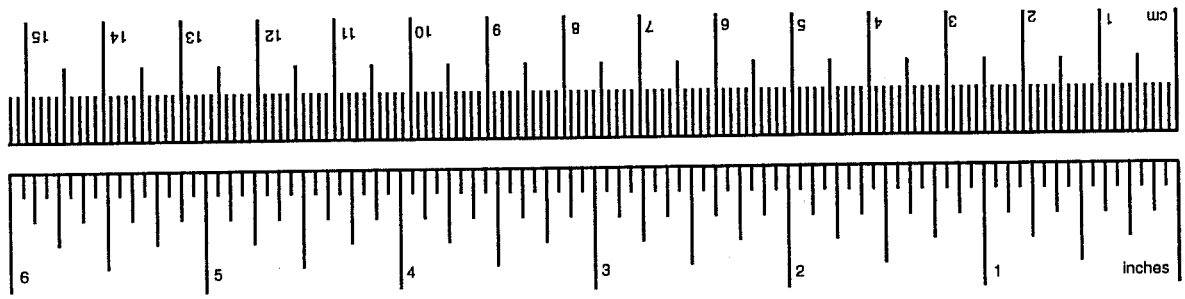

### TEMPERATURE (exact)

°F	Fahrenheit temperature	5/9 (after subtracting 32)	Celsius temperature	°C
----	------------------------	----------------------------	---------------------	----

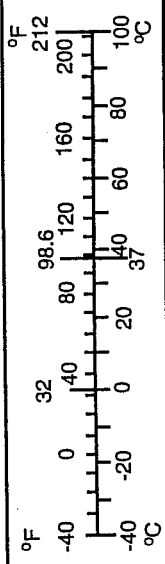

These factors conform to the requirement of FHWA Order 5190.1A.

\* SI is the symbol for the International System of Measurements

## **SUMMARY**

The various sources and consequences of damage to epoxy-coated reinforcement were studied. For inspection of damage before placement, holiday detectors were evaluated. Potential damage resulting from concreting operations such as placement and consolidation was investigated. To examine the quality of the coating following application, a hot water bath test was evaluated. Finally, corrosion performance of the epoxy-coated reinforcement was evaluated by cyclic immersion of bars with different damage levels in a salt water solution. Based on the findings, recommendations are provided for modifying current inspection, fabrication, patching, and placement procedures.



## **IMPLEMENTATION**

Information related to the inspection, fabrication, and installation of epoxy-coated bars in practice was gathered. The work confirmed the susceptibility of the coated bars to damage during fabrication (bending) and during concrete vibration. It was shown that corrosion progression on damaged spots, in a corrosive environment, could be severe and accompanied by underfilm corrosion as well as disbonding of the coating. The work also confirmed that current patching practices are not effective. In evaluating quality control procedures, it was found that holiday detectors alone were not reliable for detecting voids or pinholes in epoxy coating applied to reinforcing bar surfaces. General and specific recommendations are made for maintaining a high-quality product and quality control system. These recommendations will have a direct impact on many of the current procedures and practices pertaining to production, handling, storage, transportation, fabrication, inspection, placement, and patching of epoxy-coated bars.



# TABLE OF CONTENTS

CHAPTER 1 – INTRODUCTION .....	1
1.1 Background .....	1
1.1.1 Coating and Fabrication Stage .....	2
1.1.2 Handling, Storage, and Transportation Stage .....	3
1.1.3 Placing Stage .....	4
1.1.4 Discussion .....	6
1.2 Application History .....	6
1.3 The Objectives .....	7
CHAPTER 2 – HOLIDAY DETECTION TEST .....	9
2.1 Background .....	9
2.2 Operation of Holiday Detector .....	9
2.3 Test Preparations and Procedures .....	11
2.3.1 Control Bars .....	11
2.3.2 Test Variables .....	12
2.4 Analysis of Results .....	13
2.4.1 Moisture .....	14
2.4.2 Speed .....	13
2.4.3 Operators .....	22
2.5 Conclusions .....	22
CHAPTER 3 – IMMERSION TEST OF BENT BARS .....	27
3.1 Introduction .....	27
3.2 Control Variables .....	28
3.3 Test Setup and Procedures .....	31
3.4 Observations of the Immersed Bars .....	31
3.5 Investigating Under the Coating .....	41
3.6 Conclusions .....	44
CHAPTER 4 – EVALUATION OF DAMAGE TO COATING DURING CONCRETE PLACEMENT .....	45
4.1 Introduction .....	45
4.2 Test Preparation .....	45
4.3 Test Procedure .....	46
4.4 Observations of Damage .....	52
4.4.1 General Observations .....	52
4.4.2 Column Base Specimen .....	52
4.4.3 Slab Specimen With #4 Bars .....	54
4.4.4 Slab Specimen With #8 Bars .....	54
4.5 Discussion of Results .....	57

CHAPTER 5 – HOT WATER IMMERSION TEST ..... 59

- 5.1 Introduction ..... 59
- 5.2 Test Setup and Procedures ..... 59
- 5.3 Test Results ..... 60
  - 5.3.1 #4 Bars ..... 60
  - 5.3.2 #8 Bars ..... 60
- 5.4 Discussion of Results ..... 62

CHAPTER 6 – CONCLUSIONS AND RECOMMENDATIONS ..... 63

- 6.1 Introduction ..... 63
- 6.2 Conclusions ..... 63
- 6.3 Recommendations ..... 64

REFERENCES ..... 65



## LIST OF FIGURES

Figure	Page
1.1 Critical stages for epoxy-coated bars that require quality control procedures . . . . .	2
1.2 Causes of defects during coating process . . . . .	2
1.3 Causes of damage to coating during handling, storage, and transportation stage . . . . .	4
1.4 Causes of damage to coating during placing stage . . . . .	5
2.1 The holiday detector used for experiment . . . . .	10
2.2 Total response using a holiday detector with variable moisture in sponge, #8 bars, Operator C . . . . .	14
2.3 Total response using a holiday detector with variable moisture in sponge, #8 bars, Operator K . . . . .	15
2.4 Total response using a holiday detector with variable moisture in sponge, #4 bars, Operator C . . . . .	16
2.5 Total response using a holiday detector with variable moisture in sponge, #4 bars, Operator K . . . . .	17
2.6 Total response using a holiday detector with variable speed of detection, #8 bars, Operator C . . . . .	18
2.7 Total response using a holiday detector with variable speed of detection, #8 bars, Operator K . . . . .	19
2.8 Total response using a holiday detector with variable speed of detection, #4 bars, Operator C . . . . .	20
2.9 Total response using a holiday detector with variable speed of detection, #4 bars, Operator K . . . . .	21
2.10 Total response using a holiday detector with wet sponge, #8 bars with cross deformations, Variable Operators . . . . .	23
2.11 Total response using a holiday detector with wet sponge, #4 bars with parallel deformation, Variable Operators . . . . .	24
3.1 Configuration and dimensions of bars used in the immersion test . . . . .	28
3.2 The protective plastic rings used for bending epoxy-coated bars . . . . .	30
3.3 Comparison of damage induced by different bending operations . . . . .	32
3.4 Schematic setup of the immersion test . . . . .	33
3.5 Experimental setup of the immersion test . . . . .	34
3.6 Progression of corrosion in the patched area of a bar in group B2 . . . . .	35
3.7 Progression of corrosion in the damaged areas . . . . .	35
3.8 Corrosion in the damaged areas on the inside portions of bends . . . . .	36
3.9 Typical corrosion observations of bars in series C and D . . . . .	36
3.10 Corrosion on holidays (small pinholes) . . . . .	37
3.11 Comparison of corrosion on holidays on bars with different deformation patterns but with the same introduced damage . . . . .	37

3.12	Corrosion on hairline cracks on bars with parallel deformations . . . . .	39
3.13	Comparison of corrosion on hairline cracks on bars with different deformations . . . . .	39
3.14	Comparison of corrosion on holidays for different damage levels . . . . .	40
3.15	Comparison of corrosion on the inside portion of bend for different introduced damage on the outside portion . . . . .	40
3.16	Corrosion propagation under the coating . . . . .	42
3.17	Corrosion spots under damaged or disbanded coating . . . . .	42
3.18	Corrosion progression on the inside of bends . . . . .	43
4.1	Details of the column base specimen . . . . .	46
4.2	Formwork details of the column base specimen . . . . .	47
4.3	Plastic-covered wire used to tie reinforcement . . . . .	47
4.4	Detail of the slab specimen with #4 bars . . . . .	48
4.5	Detail of the slab specimen with #8 bars . . . . .	48
4.6	Formwork details of the slab specimen with #4 bars . . . . .	49
4.7	Formwork details of the slab specimen with #8 bars . . . . .	49
4.8	Vibration of the column base specimen . . . . .	50
4.9	Vibration of the slab specimens . . . . .	51
4.10	Washing the bars after concrete removal . . . . .	51
4.11	Damage due to vibration on the top side bars in the column specimen . . . . .	53
4.12	Damage due to vibration on the bottom side bars in the column specimen . . . . .	53
4.13	Damage due to vibration on #4 bars – slab specimen . . . . .	55
4.14	Damage due to vibration on #8 bars – slab specimen . . . . .	56
5.1	Schematic setup of the hot water immersion test . . . . .	60
5.2	Deterioration of exposed areas on #4 bar with parallel deformations . . . . .	60
5.3	Deterioration of exposed areas and holidays on #4 bar with cross deformations . . . . .	61
5.4	Deterioration of exposed areas on #8 bar with parallel deformations . . . . .	61
5.5	Deterioration of exposed areas on #8 bar with cross deformations . . . . .	61

## LIST OF TABLES

Table		Page
2.1	Types of Damage in #4 and #8 Tested Bars . . . . .	12
3.1	Immersion Test Variables for Series A and B Bars . . . . .	29
3.2	Immersion Test Variables for Series C and D Bars . . . . .	29
4.1	Percentage of Damage Due to Vibration for the Column Base Specimen . . . . .	52
4.2	Percentage of Damage Due to Vibration for the Slab Specimen With #4 Bars . . . . .	55
4.3	Percentage of Damage Due to Vibration for the Slab Specimen With #8 Bars . . . . .	55



# CHAPTER 1 INTRODUCTION

## 1.1 Background

It is well known that concrete protects the embedded reinforcing steel from corrosion under normal exposure conditions. Steel normally develops a protective iron oxide film over its surface when surrounded by the highly alkaline concrete environment. In such a case, steel is said to be in a passive state due to the formation of a passivation layer. This protective layer may not be formed or may be destroyed when (1) concrete does not fully encase the steel; (2) alkalinity is lost by reaction with greases and liquids; or (3) excessive amounts of chloride or other aggressive ions are present.<sup>5</sup>

The sources of chloride ions in concrete can be either external or internal. Exposure to seawater and de-icing salts are the main external sources, while contaminated aggregate and seawater used for mixing are the main internal sources.

Chloride ions attack the steel and destroy the passivation layer. Once steel is depassivated, corrosion electrochemical reactions start in the presence of water and oxygen. In the corrosion process, rust products occupy a greater volume than the original steel. The resulting expansive rust formations exert high internal pressures that lead to concrete cracking and spalling. The corrosion-induced damage may be severe, and may cause significant structural problems.

There are many techniques being developed to prevent corrosion of the reinforcing steel. Coating the bars with a highly insulative material is generally considered to be an effective way of reducing corrosion. The most widely used coating is epoxy.<sup>7</sup> Epoxy coating has two functions: first, it provides a barrier at the bar surface against chloride attack; and second, it serves as an electrical isolator.

The epoxy used for coating reinforcing bars is usually a bisphenol-amine formulation, applied at a temperature near 450° F over sandblasted bars with electrostatic spray guns.<sup>1</sup> The process in which epoxy powder is deposited and cured on the bar surface is known as the fusion-bonding process. After coating, the bars go through a cooling and quality control procedure.

Quality control procedures for epoxy-coated bars can be implemented at three stages: (1) coating and fabrication; (2) handling, storage, and transportation; and (3) placing. Figure 1.1 shows the movement between stages. Each stage involves different processes that influence the quality of the coating. In the following discussion, the possible damage that may occur during each stage and the related specifications that govern the quality control procedure are addressed.

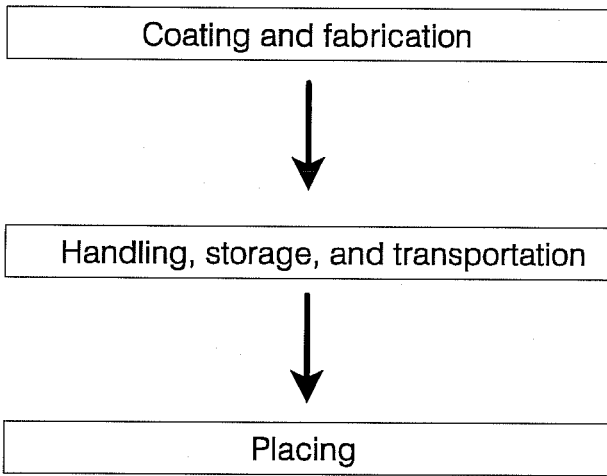

Figure 1.1 Critical stages for epoxy-coated bars that require quality control procedures.

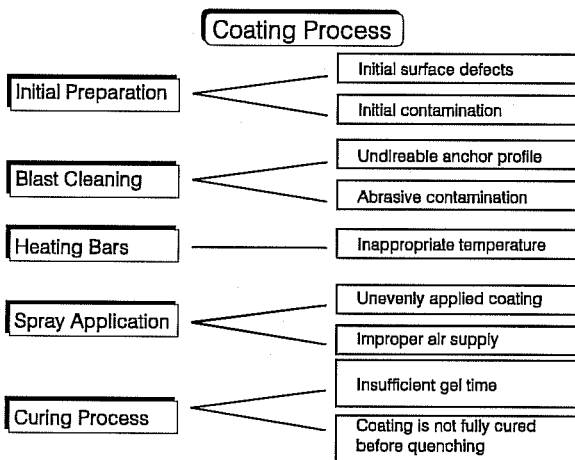

Figure 1.2 Causes of defects during coating process.

**1.1.1 Coating and Fabrication Stage.** The process for coating bars with epoxy is done in stages. To achieve a quality product, a correct and complete understanding of the quality control procedure at each stage is necessary.<sup>8</sup> During the coating process, many factors can lead to defects of coating such as those shown in Figure 1.2. Although several institutions including CRSI, ASTM, and NACE provide guidelines for quality control, a perfect product without defects cannot be expected. Therefore, inspection and repair processes need to be established to minimize the defects.

Epoxy should be applied to bars that are clean and free of visible contaminants. Contaminants such as oil, grease, paint, and salt will interfere with the molecular adhesion of the coating to the steel and result in disbondment of the coating. For this reason, visible inspection for oil, grease, paint, and salt should be carried out and documented. In addition, the manufacturer should also check on the existence of detrimental surface defects before the bar goes through a blast cleaning process. Surface defects are excessively sharp and angular deformations or visible slivers on surfaces. Experience has shown that bars with these defects would be very difficult, if not impossible, to coat properly.

Coating will flow away from sharp edges and result in inadequate thickness at these points. Specifications at the time this project was initiated limited the thickness to a range of 5-12 mils.<sup>11, 12</sup>

The next step involves cleaning the bars by abrasive blasting. It is necessary to have a clean steel surface in order to produce a strong adhesive bond between the coating and the steel. A number of tests are recommended in the CRSI quality control plan to verify the effect of the blast-cleaning operation.<sup>8</sup> After cleaning, the surface condition of the bars should be compared with the latest visual check standard provided by the Steel Structures Painting Councils (SSPC-V1S1). Personnel should continuously monitor the appearance of the bars as they exit the blast-

cleaning operation and compare the samples with the SSPC-VIS1-89 visual standard to determine if they meet the requirement of SSPC-SP10 (Near White Blast Cleaning).<sup>15</sup> CRSI also recommends several test methods to investigate chloride contamination as well as mill-scale, dirt or rubber, and backside contamination.

The adhesion of the coating is dependent on the surface area available to form polar molecular bonds with the coating as well as on the cleanness of the surface. Proper blast-cleaning will result in a maximum number of peaks and valleys which ensure that the maximum surface area of the steel is exposed. The surface profile coefficient provides an objective standard of this requirement.

Blast abrasives may become embedded in or leave residue on the surface of the steel. Harmful contaminants exist in blast abrasives and will reduce the effectiveness of the coating. Several tests are recommended to investigate oil contamination and chloride contamination. Also, a sieve analysis is suggested to assure that an appropriate abrasive mix was used.

The coating powder used should meet the requirements of ASTM-A775.<sup>12</sup> A prequalification test should be made to make sure that a specific coating powder is appropriate. This test includes chemical resistance, resistance to applied voltage, chloride permeability, adhesion of the coating, bond strength to the concrete, abrasion resistance, impact, and hardness. In addition, the powder should be stored in the manufacturer's unopened container at an ambient temperature not greater than the manufacturer's recommended storage temperature. No powder should be used if its shelf life has expired.

After all cleaning processes are complete, the bars are heated by induction heating and then sent into the electrostatic spray chamber. The spray guns are usually mounted at different angles to ensure uniform coating. The bars then pass through a water-quench system and a quality control system (to be discussed in detail later) on wetted, nonmetallic rollers. If the coating is not fully cured at the end of these processes, severe damage may occur during subsequent stages. Therefore, it is essential to maintain gel times specified by the epoxy powder manufacturer.

Fabrication of coated bars may cause coating disbondment to some degree over the bent portions. Poor surface preparation aggravates loss of adhesion under the "stretched" coating. If the epoxy coating is not flexible enough, breaks in the form of hairline cracks often appear on the outside of the bend. In addition, bending using an unprotected metallic mandrel will result in mechanical damage. This damage appears as scraped or mashed spots on both the outside and inside bent portions.

**1.1.2 Handling, Storage, and Transportation Stage.** In this stage, most damage results from bar-to-bar collision. A list of some possible causes of damage during this stage is shown in Figure 1.3. When the bars are tied in a bundle, the coating will be damaged because of scraping, friction, and rubbing with bars or any other hard surface.

Common sense is needed when loading or unloading the epoxy-coated reinforcing bars. Specifications have been established for preventing damage during this stage: (1) all systems for handling shall have padded contact areas; (2) all bundling bands shall be padded or made of suitable material to prevent damage; and (3) bundles shall be lifted with a strong back, spreader bar, multiple support, or platform bridge to prevent bar-to-bar abrasion from sags in the bundle.<sup>6, 11</sup>

Caution must be taken all through the handling process. For example, in unloading the epoxy-coated bars, care must be exercised to minimize scraping of the bundles or bar-to-bar abrasion. Skidding the bars from the truck bed could produce severe damage to the coating. Power-hoisting equipment should be used to move the bars. In addition, coated bars or bundles of coated bars should not be dropped or dragged.<sup>11</sup>

It is not recommended that the coated bars be left outdoors for a long period. If it is necessary to do so, the following precautions should be followed: (1) store the bars above the ground on timbers or on other suitable protective cribbing; (2) space the dunnage close enough to prevent sag in the bundles; (3) stack bundles of straight bars with adequate blocking placed between layers of bundles; (4) cover the bars or bundles with opaque sheeting; (5) drape the cover around the perimeter of the stack, and allow air to circulate to prevent condensation under the cover; and (6) use nonmetallic identification tags to avoid further scraping between bars and the tags.<sup>6</sup>

All the processes discussed above need to be carried out carefully and patiently. Otherwise, damage will be incurred which may lead to loss of integrity and serious structural problems.

**1.1.3 Placing Stage.** At the job site, certain specifications and operations should be followed to maintain high-quality epoxy-coated reinforcing steel performance. There are several possible causes of damage to coating during the placing stage, as depicted in Figure 1.4.

It should not be expected that epoxy-coated reinforcing bars will be completely free of damage. Some damage is inevitable during shipping, handling, and placing. In fact, most project specifications permit individual damaged spots up to a certain area or size. Typically, the limit in project specifications on acceptable spots of damaged coating is in the order of 0.063 in<sup>2</sup> (1/4 in. x 1/4 in.).<sup>6</sup> All damaged spots larger than 0.063 in<sup>2</sup> need to be repaired. The

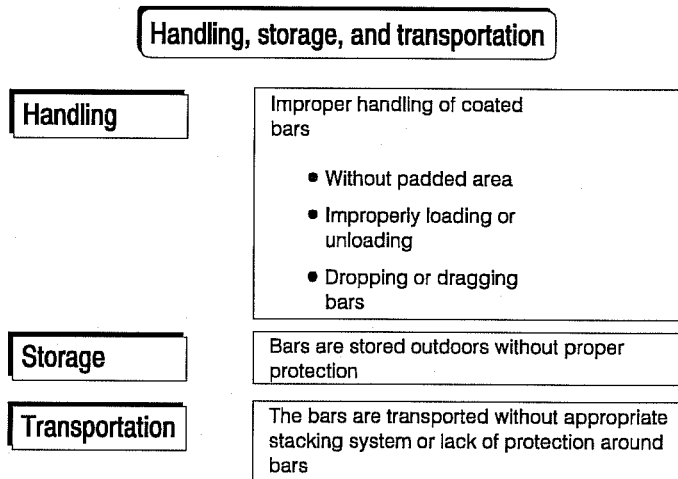

**Figure 1.3** Causes of damage to coating during handling, storage, and transportation stage.



specifications require that damage from processes in the plant or during shipping and handling that exceeds the limit should be repaired with the same patching material used in the plant. Specifications also limit the maximum amount of total coating damage to 2% of total surface area per linear foot of the coated bar. In addition, the total area patched is limited to 5% of the total surface area.<sup>6</sup> The sheared end of epoxy-coated bars should be patched at the plant. Occasionally some touch-up of the sheared end may be missed and the end must be coated at the job site with the same patching material used to repair the damage.

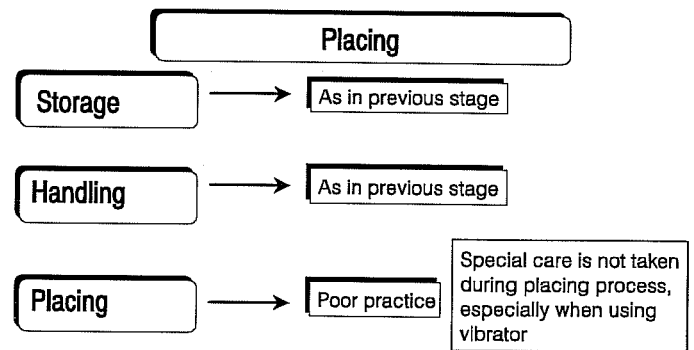

Figure 1.4 Causes of damage to coating during placing stage.

Long-term storage of epoxy-coated reinforcing bars at the job site is usually not recommended. Should circumstances or other conditions make it necessary to store the coated bars for an extended period of time, the storage guidelines discussed under Section 1.1.2 should be followed.<sup>6</sup>

In general, placing epoxy-coated bars is similar to placing uncoated bars, except that more caution is needed to avoid damage to the coating. Dragging coated bars over others or dropping them is prohibited. Usually, if careful practices are followed, repairs required for damaged coating can be reduced significantly.

Noncorrosive bar supports and tie wires should be used with epoxy-coated bars to minimize corrosion damage at their contact areas. Such elements are usually coated with epoxy or other nonmetallic material to become acceptable. In this regard, the following recommendations are given to improve the protection of coated bars:

- 1) Wire bar supports should be coated with a dielectric material such as epoxy or plastic that is compatible with concrete.
- 2) Bar supports should be made of a dielectric material.
- 3) Wires or dowels used in precast concrete should be epoxy-coated or plastic-coated.
- 4) Reinforcing bars that are used as support bars should be epoxy-coated.
- 5) Spreader bars in wall construction should be epoxy-coated.
- 6) Proprietary combination bar clips and spreaders should be made of a corrosion-resistant material or coated with a dielectric material.<sup>6</sup>

Covered tie wires are often used to minimize damage to the bar coating. The covering material on the wire is usually epoxy, plastic, or nylon.

Field bending or straightening should be avoided if possible. Damage to the coating by field operations could be detrimental to the future performance. Even when the damaged areas are patched, these areas will have a greater corrosion propensity, especially if located in the vicinity of a construction joint. Practices such as splicing and cutting of coated bars should be done with great care. It is strongly recommended that all parts of the installed splice be properly coated with a compatible patching material using appropriate tools. Inspection of splices prior to concrete placement is necessary to assure good quality patching. Field cutting can be done only as permitted by the engineer. Using saw cutting rather than flame cutting can reduce the area that needs repair or touch-up. Job specifications should require that after completion of field installation of coated bars, all damaged areas should be patched with the repair epoxy compatible with the original.<sup>6</sup>

**1.1.4 Discussion.** From the review above, it can be seen that damage to coating is possible at any stage. However, with proper inspection before placing the concrete, coating damage can be detected and repaired to improve the performance of the coating.

Indeed, the coating process must be executed properly. It is impossible to achieve a long-term protection against corrosion with poorly coated bars. During the coating process, quality control procedures must be seriously considered and successfully carried out. Required tests should be done at specified phases of production and time intervals. The enthusiasm and understanding of personnel at the coating plant are essential for maintaining a high-quality product.

Even if the coating was perfectly applied, no successful performance of the epoxy-coated bars can be guaranteed without careful inspection and repair of damaged coating. Damage to coating occurs anytime the bars are carelessly handled. Although the repair of damage is required by specifications, it is not certain whether damage can be detected effectively or not. Furthermore, additional information is required about the performance of the repaired sections. In this study, uncertainties about detection and repair will be evaluated.

## 1.2 Application History

Epoxy-coated steel bars have been in use since the early 1970s. Their good performance in several highway projects has been encouraging. Compared to uncoated steel bars, epoxy-coated bars have exhibited less corrosion, which has led to their wide use in a variety of structures.<sup>5</sup>

However, recent observations of the performance of epoxy-coated reinforcing bars used in some bridges located in the Florida Keys show that corrosion is not always prevented. Subsequently, further investigation and research were initiated to better understand the behavior

of the epoxy-coated bars and to study the conditions necessary for their successful implementation.<sup>6</sup>

### 1.3 The Objectives

The use of epoxy-coated reinforcing steel is one possibility for improving the durability of concrete structures. Achieving a satisfactory performance of the coated bars depends on the quality of the coating material and the quality of the finished product in service. Epoxy coatings may have imperfections, as well as surface damage caused by different operations during all stages from coating to placement. Concerns have been raised about how well the coating defects can be detected, and what are the tolerable limits of unrepaired damage to coating. Further, the protective qualities of the coating with mechanical damage and possible disbondment due to fabrication have also been questioned in the last few years.

This study, as part of a more comprehensive investigation of the structural integrity of epoxy-coated reinforcement, deals with some inspection techniques and evaluation of damage to coated bars. To this end, efforts have been concentrated on studying a number of performance-related tests, inspection-related practices, and factors contributing to damage of epoxy-coated reinforcement.

The objectives of this study can thus be summarized as the following:

- A) Evaluating the effectiveness of holiday detectors. These are devices widely used to inspect the integrity of the coating. The details of this part of the study are given in Chapter 2.
- B) Testing the performance of epoxy-coated bent bars. An immersion test has been used to compare the performance of "U" bent bars with different levels of induced damage. This accelerated test is the subject of Chapter 3.
- C) Assessing the possible damage to coating introduced while vibrating concrete. Chapter 4 describes the procedures followed for this assessment.
- D) Experimenting with an alternative hot water immersion test for quality control. The adequacy of coating can be checked by this test, which is illustrated in Chapter 5.



## CHAPTER 2 HOLIDAY DETECTION TEST

### 2.1 Background

In order for a corrosion "barrier" to perform properly, a continuous layer of a sound coating material must be provided around the bar. The term frequently used to describe tiny discontinuities in the coating is *holiday*. A holiday is a very small discontinuity (pinhole) of the coating that exposes the metal surface to the environment or exhibits electrical conductivity when exposed to a predetermined voltage. The size limits of holidays are not precisely defined but usually they are so small they cannot be detected with the unaided eye.

A device used to monitor the quality of the coating is called a "holiday detector." It is defined as an electrical device that locates voids or flaws in thin film paint or coating applied to metal surfaces.

Detection and correction of defects in protective coating are important factors in an effective corrosion control system. Inspection for holidays is usually done at the coating plant prior to installation; it is done much less often at the job site. The holiday detection test at its best indicates the continuity of epoxy coating and is required by specifications such as ASTM D3963 and ASTM A775.<sup>11,12</sup> The test is not intended to provide information on coating resistance, bond, physical characteristics, or the overall application quality. It is used to detect voids, cracks, foreign inclusions, or contamination in the coating that are of such a size, number, or conductivity as to significantly lower the electrical resistance or dielectric strength of the coating.<sup>3</sup>

### 2.2 Operation of Holiday Detector

The operation of a holiday detector is based on the conductivity of defects present in a coated surface. There are two main parts in a holiday detector: the grounded end and the exploring electrode (usually with a damp sponge). Proper electrical grounding of the holiday detector to the base metal of the tested bar as well as conductive defects in the coating are necessary to complete the electrical circuit. The exploring electrode is the means by which the electrical potential is applied to the surface of the coating. Normally, 67.5 volts DC are applied to the dampened sponge. Then the sponge electrode is either moved over the surface to be inspected or kept stationary while the rolling bar touches it. The latter arrangement which is common at the coating plants is referred to as in-line detection. As the sponge passes over a void, the dampness provides the electrical conductivity to permit a small current to pass. As a result, a transistor oscillator is triggered, generating an 800-cycle audio signal. The low voltage and current involved qualify this as a nondestructive test.

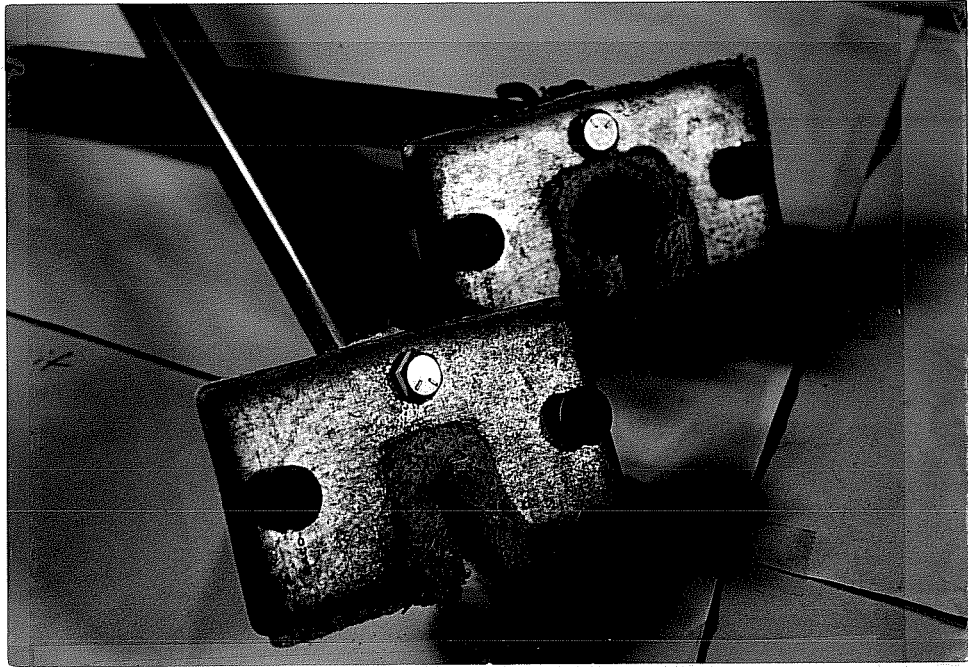

(a) Sponges used for #4 and #8 bars

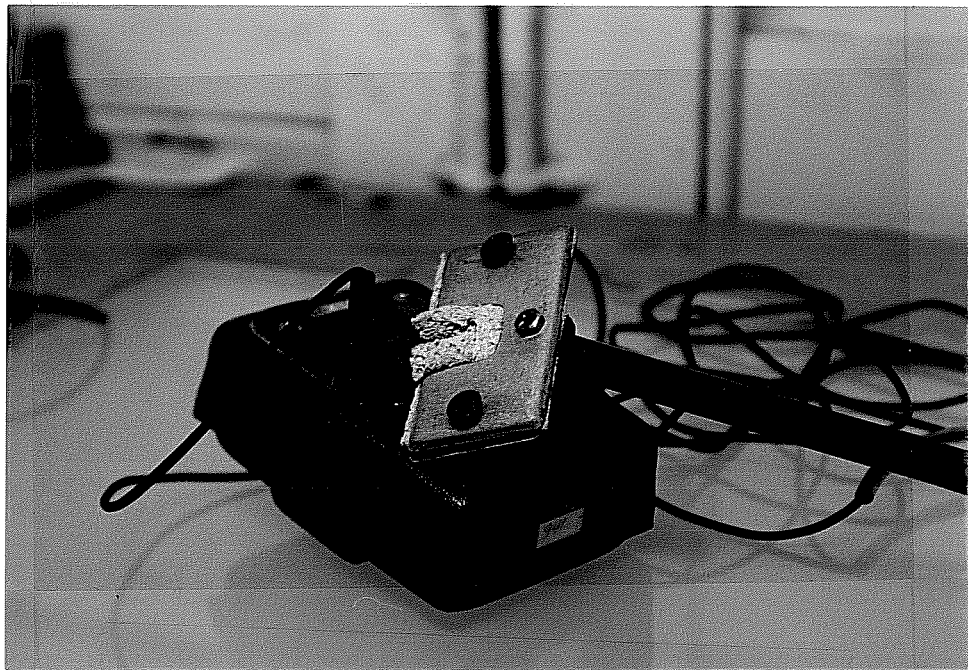

(b) The holiday detector device

**Figure 2.1 The holiday detector used for experiment.**

When in-line detection is used, the major problem lies in achieving continuous contact with the bar base metal. One possibility is to use the metallic rollers that push the bar into the coating chamber to make electrical contact between the holiday detector and the bar metal surface. The sponge electrode is normally placed at a point away from the coating chamber to inspect the coated surface after the bar cools down by water quenching. Once the bar end passes the last metallic rollers to enter the coating chamber, the electrical contact is lost. The distance between the sponge and the bar's end will not be inspected. Another possibility of grounding is to utilize the water bath system as part of the electrical circuit. The water is electrically charged so that when it comes in contact with conductive defects in the coating at the same time the sponge electrode is passing over a holiday, the detection signal is triggered. This solution may not be practical because of the difficulty in isolating water from the metal frame of the production line. In addition, water contact points need to be closely spaced to allow for continuous detection.

Some important guidelines for improving the effectiveness of the electrode in holiday detection are: (1) the construction of the exploring electrode should be such that contact between the electrode and the coated surface is maintained at all times; (2) the exploring electrode should be kept clean and free of coating material and/or rough surfaces that might damage the coating<sup>3</sup>; and (3) grounding with the base metal should be properly maintained to allow continuous detection of the coated surfaces.

For the purpose of this study, the device selected for testing was a sponge-type, hand-held holiday detector (Figure 2.1). For use with reinforcing steel bars, the sponge was modified to provide closer contact between the coated surface and the sponge electrode. Two different sponges were used, one for #4 bars and one for #8 bars.

### 2.3 Test Preparations and Procedures

To evaluate the factors that may influence the results obtained by using a holiday detector, a series of controlled tests was conducted in which a number of variables were considered. A group of coated control bars was set up with differing degrees of damage. The operations were also varied to reflect a wide spectrum of possible testing conditions.

**2.3.1 Control Bars.** A total of 12 epoxy-coated #4 and #8 bars with parallel- and cross-type deformations were tested. These bars were selected from the same lot and were coated under identical conditions, with an average coating thickness of about 10 mils. Since the current use of holiday detectors is generally limited to inspecting straight bars during the coating process, the control bars tested here were also straight. Holidays and hairline cracks were deliberately introduced in the coating of some bars. The damage conditions were as follows.

As received: no additional damage introduced.

Pinholes: small pinholes introduced.

Hairline cracks: several small hairline cracks introduced by cutting the bars with a utility knife.

**Table 2.1** Types of Damage in #4 and #8 Tested Bars.

Bar Number	Deformation Type	Type of Damage
1	Parallel	As received
2	Cross	As received
3	Parallel	Hairline cracks
4	Cross	Hairline cracks
5	Parallel	Pinholes
6	Cross	Pinholes

The kinds of damage introduced for each bar are shown in Table 2.1. The 2-ft-long bars were divided into five regions (each about 5 in. long) marked by red ink. As the holiday detector was passed along the bar, the operator counted the horn signals (beeps) in each 5-in. region. The number of these signals was considered to be equivalent to the number of voids or pinholes encountered in the tested region. Five replicate passes were conducted for each tested condition (variable) as will be explained below.

**2.3.2 Test Variables.** (1) Moisture in Sponge:

Moisture in the electrode sponge is necessary to complete the electrical circuit where discontinuities in the coating have been spotted by the holiday detector. The conditions of moisture affect the sensitivity of the electrical continuity and may, consequently, affect the reliability of the detection. No response is expected when the electrode sponge is completely dry. Other moisture conditions need to be tested to establish their influence on the detection. In this study, three levels of moisture were selected. The following terms were used to describe the dampness of the sponge:

Wet: sponge dipped into water, removed without squeezing, and used when no excess water was dripping from sponge.

Squeezed once: sponge dipped into water and squeezed once.

Well-squeezed: sponge dipped into water and squeezed to remove as much water as possible.

(2) Speed of Operation: Three different speeds of detection were used to assess the differences in responses as a function of travel time. By varying the time the sponge is passed over the whole bar, the ability of the operator to judge on the number of voids he encountered (represented by the number of horn signals) is examined. The following notations were used to describe speed of operation:

Fast: sponge electrode passed along the bar in 1 to 2 seconds.

Medium: sponge electrode passed along the bar in 3 to 4 seconds.

Slow: sponge electrode passed along the bar in 5 to 6 seconds.

(3) Operator: Three different operators (C, K, and R) conducted the same detection tests to evaluate repeatability of the test results. Each operator inspected the 12 control bars using three different speeds of operation, and for each speed three different moisture conditions



of the sponge were employed. Every bar pass at a certain speed and with a particular sponge dampness was repeated five times to generate enough data for comparison.

## 2.4 Analysis of Results

For each region of the bar in each test condition, the responses (horn signals) from the five passes were added and plotted. In the following figures, the vertical axis represents the total number of responses and the horizontal axis represents the region along the bar. The results are discussed under the same variable titles presented earlier.

**2.4.1 Moisture.** Figures 2.2 and 2.3 show the responses obtained by operators C and K for #8 bars with parallel and cross deformation patterns. It can be seen that the deviation was not significant for different moisture conditions when the detector was operated at a fast or medium speed. However, when the speed of operation was slow, the responses showed more deviation for different moisture conditions. It may appear that more holidays can be detected with more moisture in the sponge, but the results were generally inconsistent.

Figures 2.4 and 2.5 show the results for #4 bars. Relatively small deviations were observed for different moisture conditions. Again, the responses obtained by both operators C and K were not consistently increasing with more moisture in the sponge.

From these observations, it appears that moisture conditions did not have a distinct influence on the results. As long as there was moisture in the sponge, the detector was able to locate discontinuities in the coating.

**2.4.2 Speed.** Figures 2.6 and 2.7 show the responses collected at different speeds for #8 bars by both operators C and K. Higher responses were observed with the slower speed. The only exception noted was for bars with hairline cracks where, in some cases, medium and fast speeds gave slightly higher responses.

Figures 2.8 and 2.9 show the corresponding responses for #4 bars. Again, the tendency was for slow readings to give slightly higher responses.

From these observations, it appears that the slower the speed of detection, the higher the number of responses obtained. This means that slow detection is more reliable and preferable.

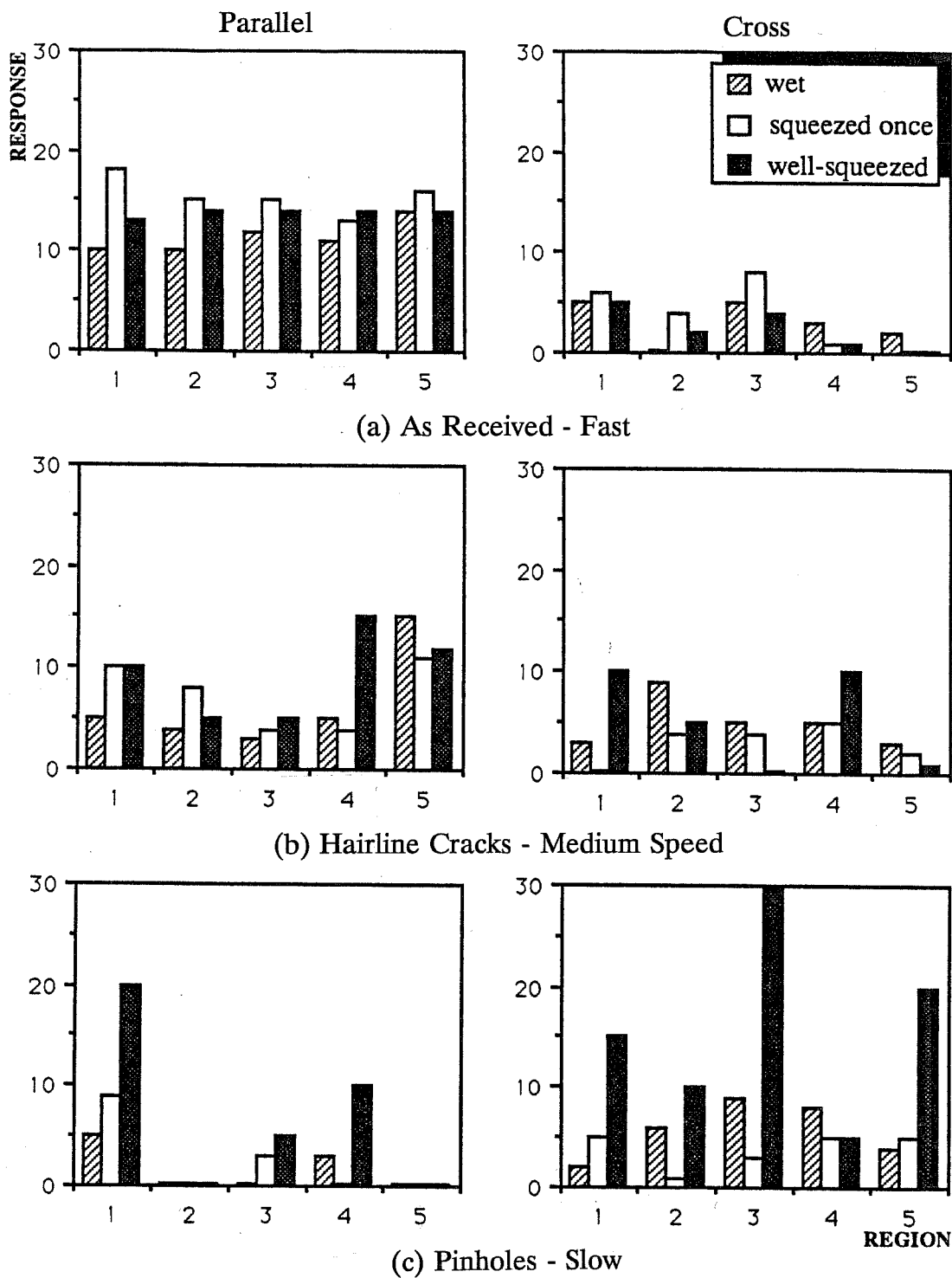
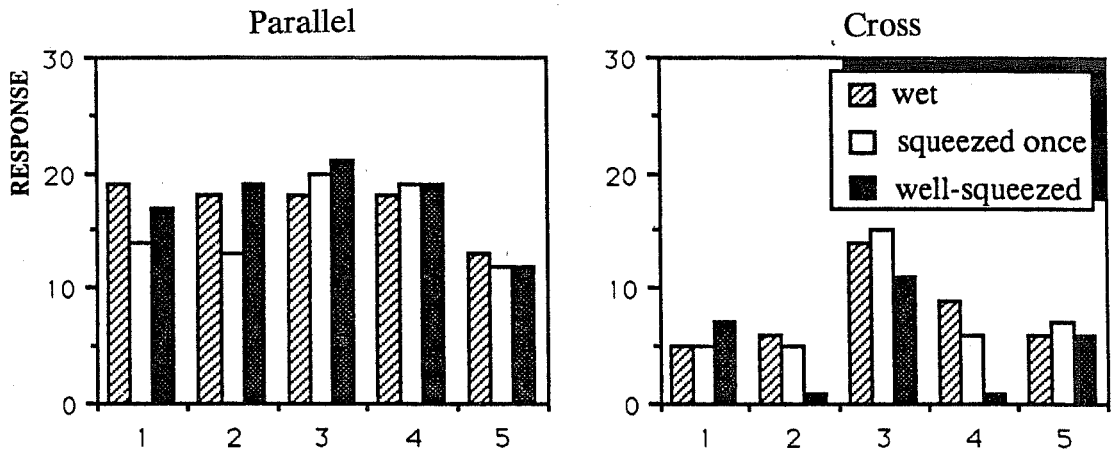
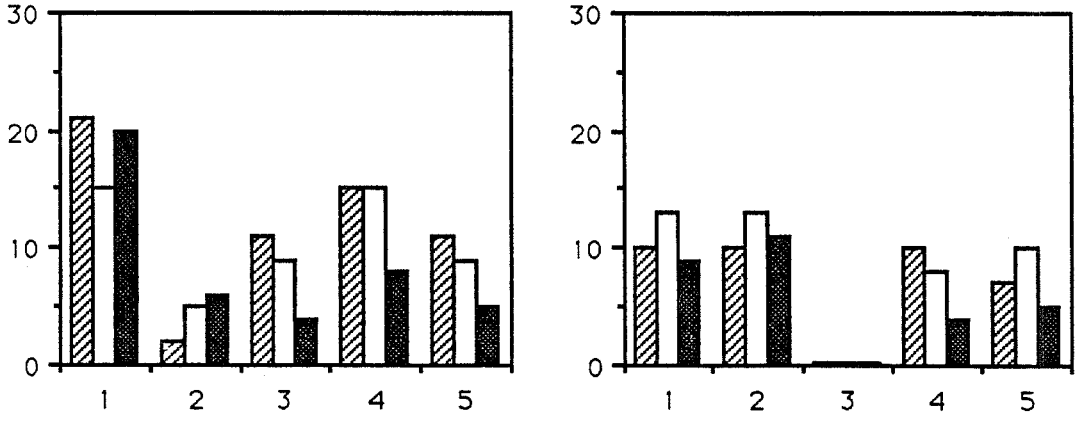

Figure 2.2 Total response using a holiday detector with variable moisture in sponge, #8 bars, Operator C.



(a) As Received - Fast



(b) Hairline Cracks - Medium Speed

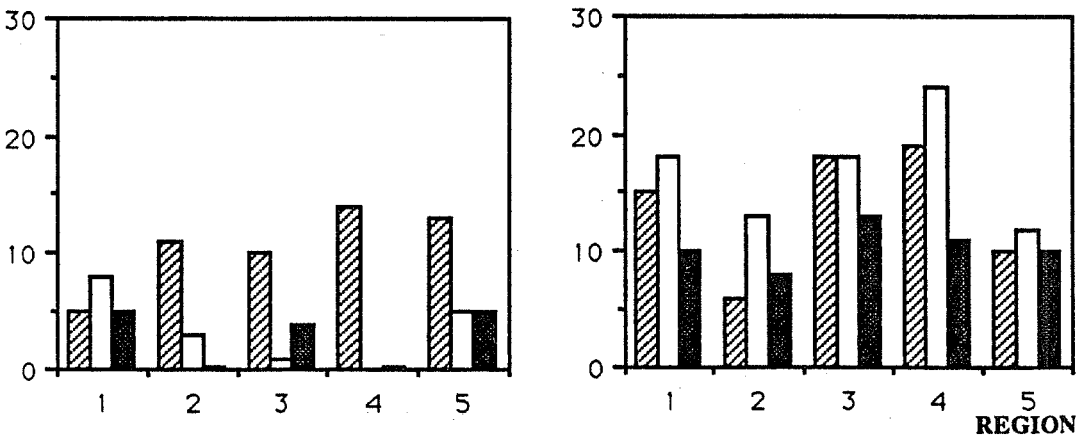

(c) Pinholes - Slow

Figure 2.3 Total response using a holiday detector with variable moisture in sponge, #8 bars, Operator K.

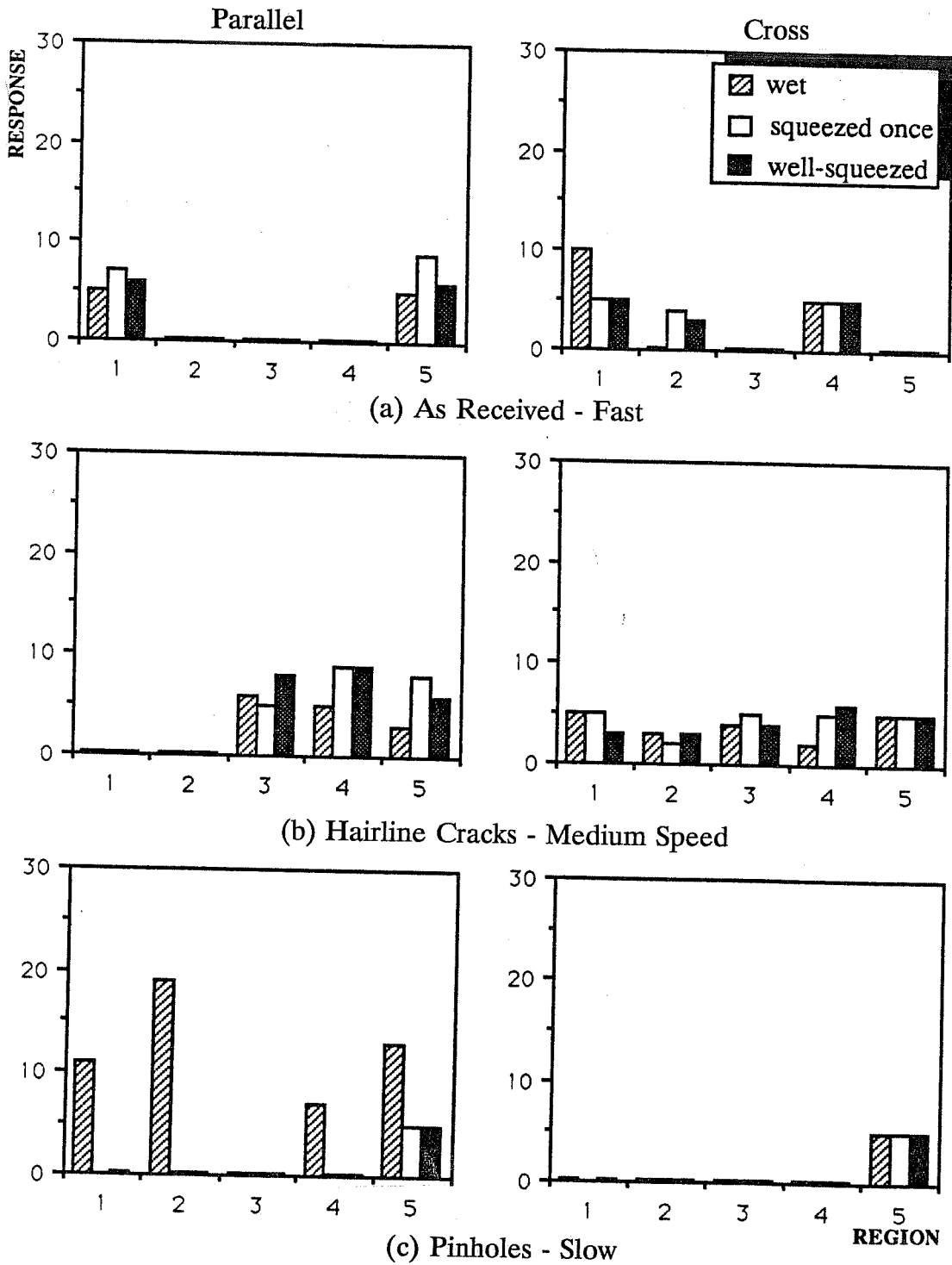

Figure 2.4 Total response using a holiday detector with variable moisture in sponge, #4 bars, Operator C.

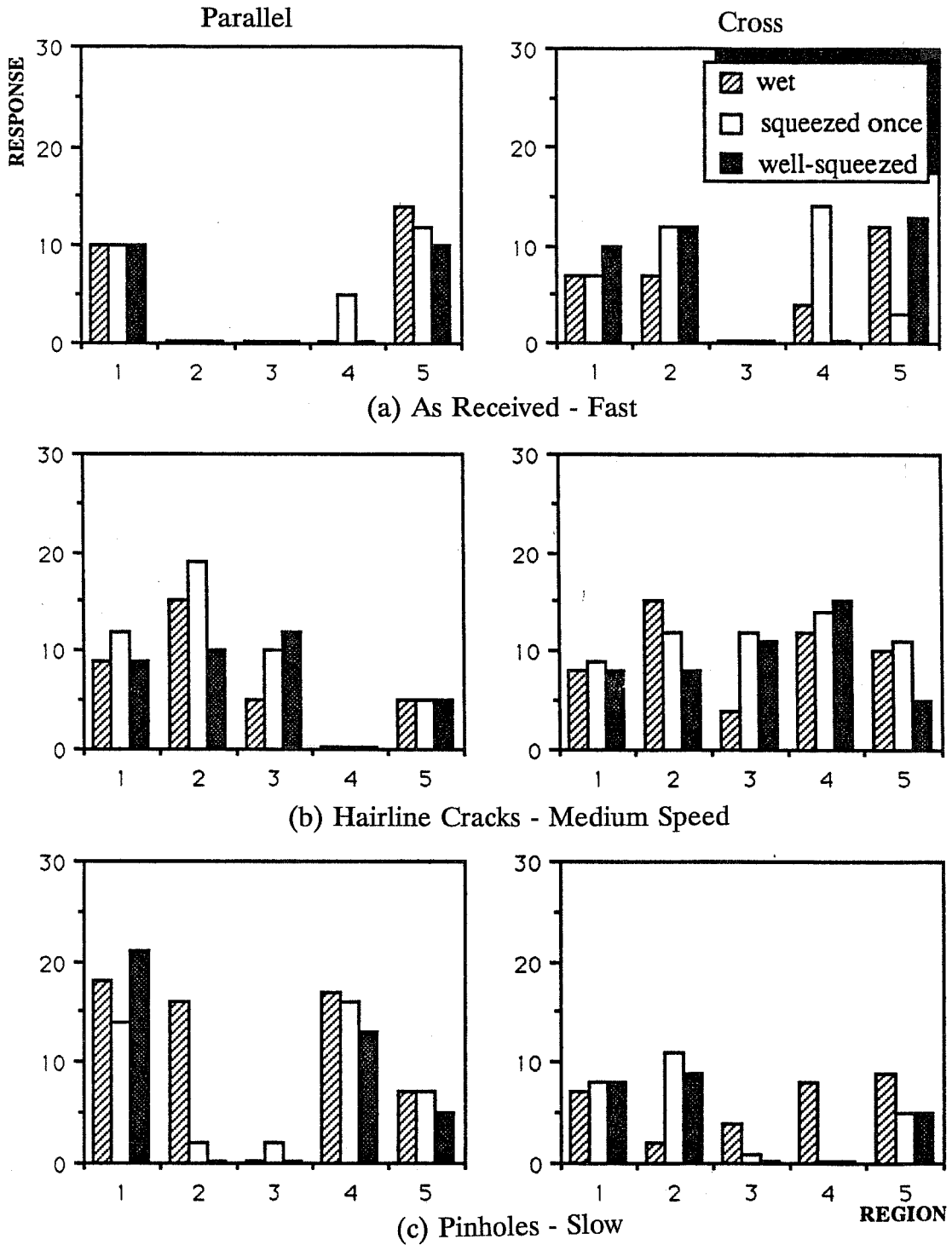

Figure 2.5 Total response using a holiday detector with variable moisture in sponge, #4 bars, Operator K.

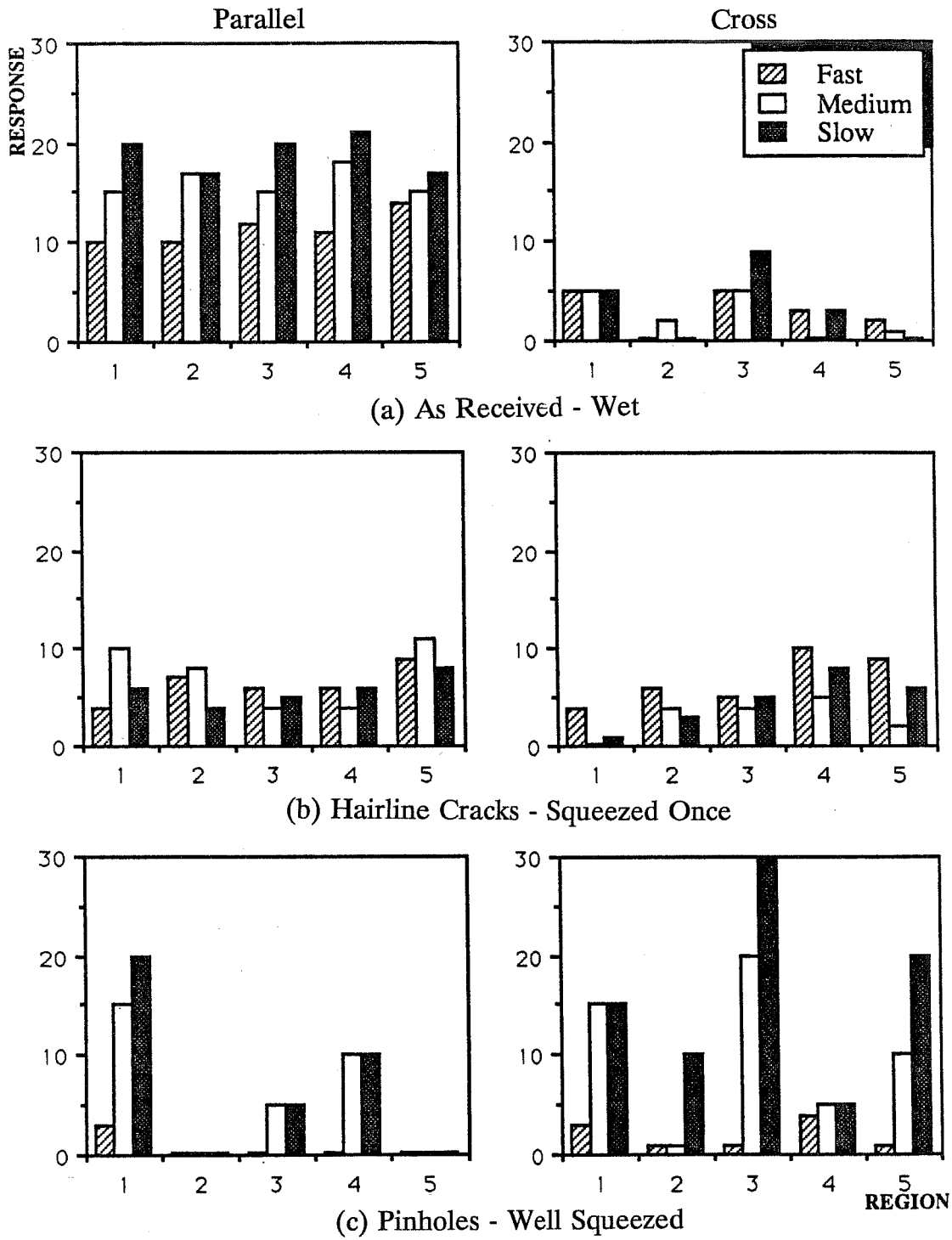
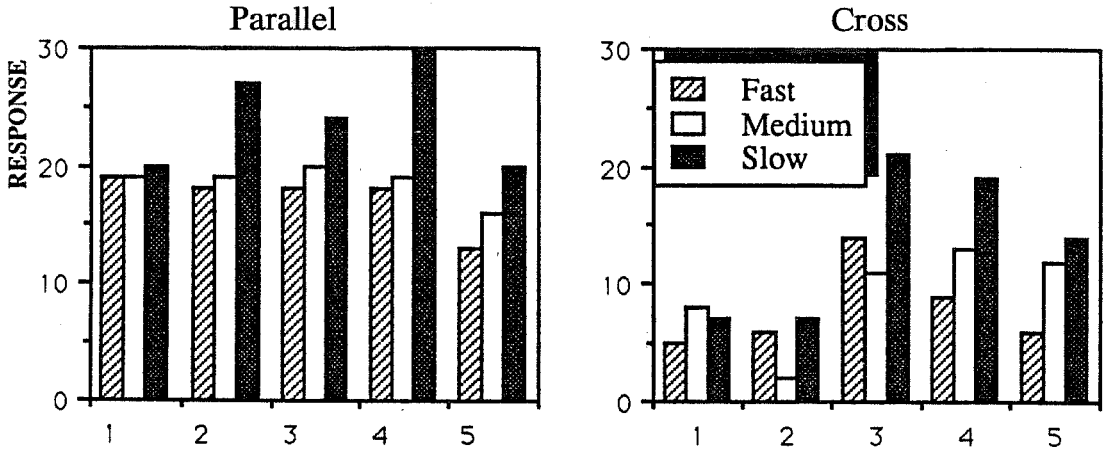
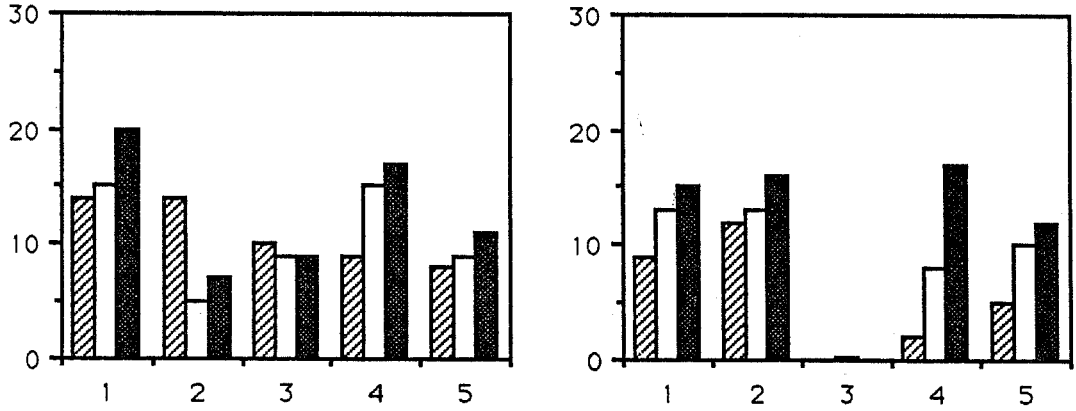

Figure 2.6 Total response using a holiday detector with variable speed of detection, #8 bars, Operator C.



(a) As Received - Wet



(b) Hairline Cracks - Squeezed Once

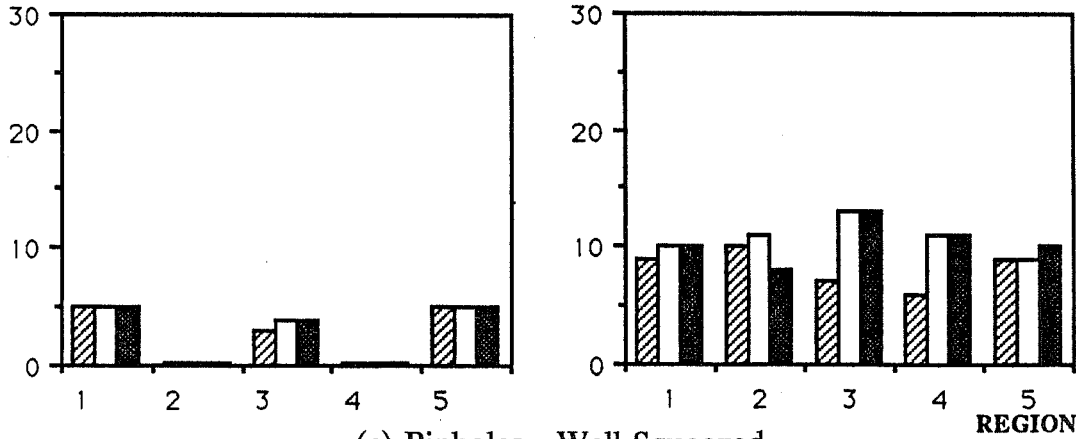

(c) Pinholes - Well Squeezed

Figure 2.7 Total response using a holiday detector with variable speed of detection, #8 bars, Operator K.

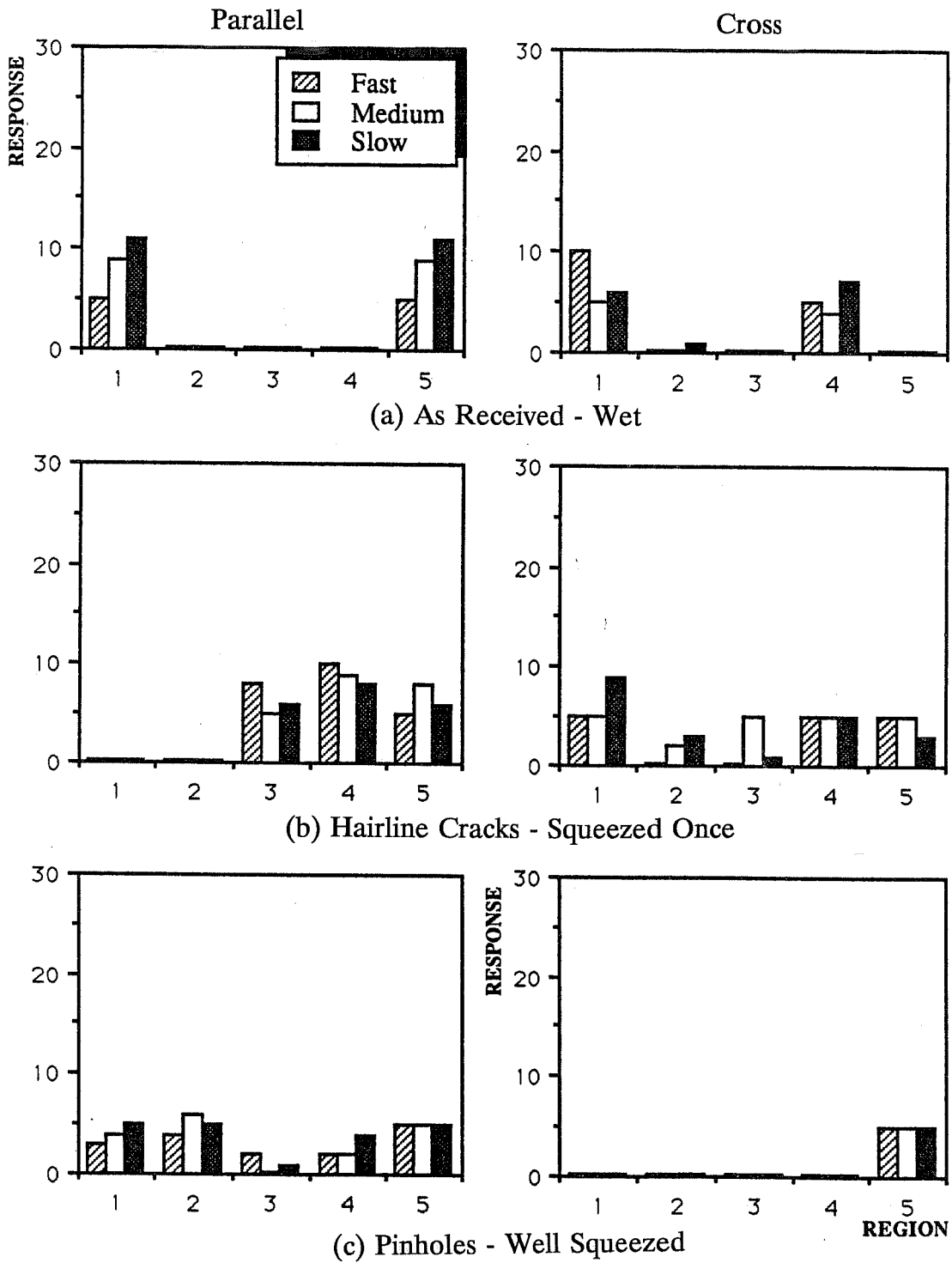

Figure 2.8 Total response using a holiday detector with variable speed of detection, #4 bars, Operator C.



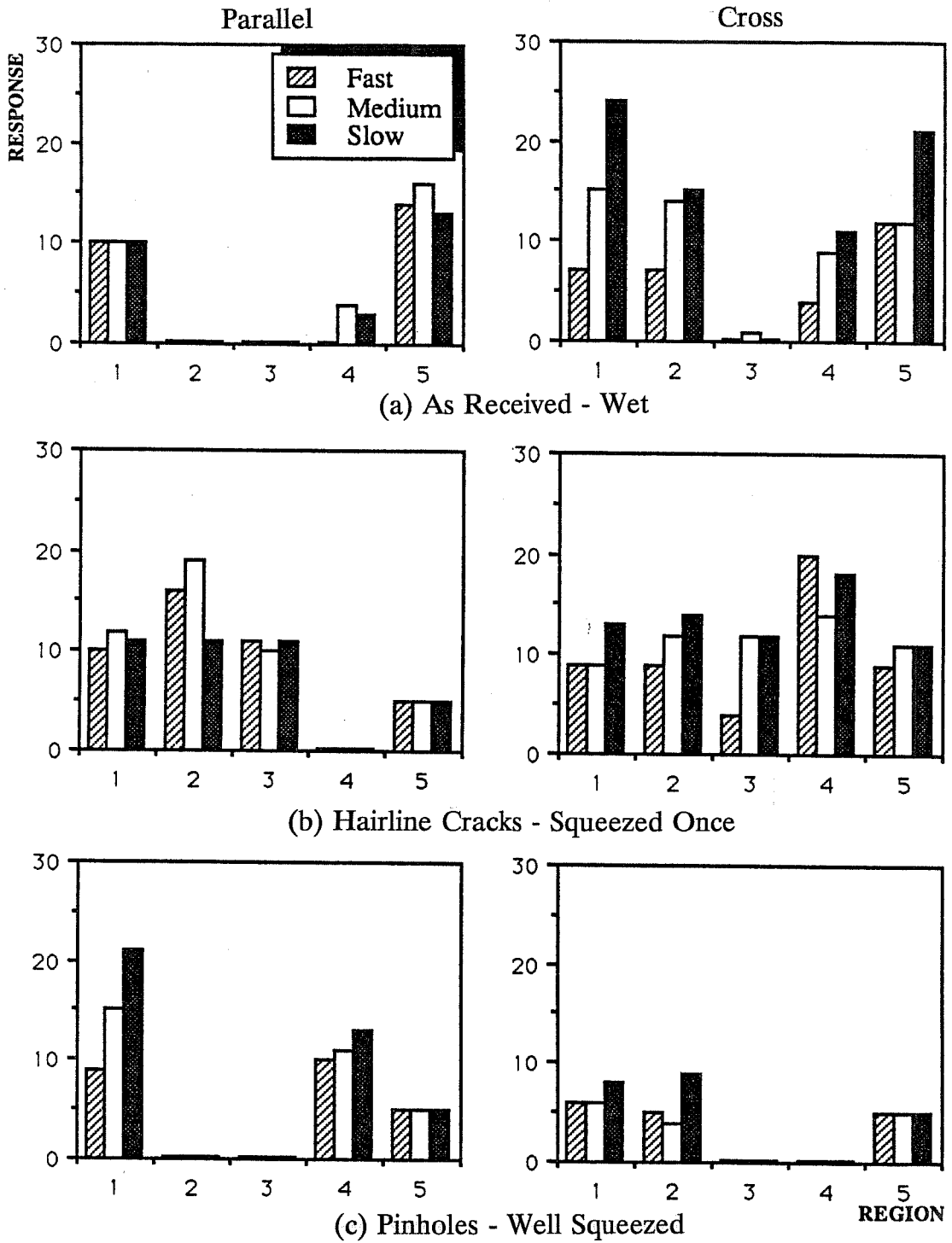

Figure 2.9 Total response using a holiday detector with variable speed of detection, #4 bars, Operator K.

**2.4.3 Operators.** The use of holiday detectors depends primarily on the operators. Therefore human errors are very significant in this test. Since personal judgements are heavily involved in determining the number of signals heard, and in assuring proper sponge/surface contact, considerable deviations between operators are expected.

As can be seen from Figures 2.10 and 2.11, responses counted by different operators deviated considerably. In addition, there was no clear tendency for one operator to consistently obtain higher or lower responses than the others. One operator might obtain maximum responses with one condition and minimum responses with another. Moreover, in the same plot no consistent relation can be found between different operators.

## 2.5 Conclusions

The effectiveness of the holiday detector was evaluated considering three variables: moisture in the sponge, operating speed, and operator. The only clear trend involved the speed of detection.

Varying the moisture conditions gave inconsistent results. In some cases, higher responses were obtained with more moisture in the sponge while in others the opposite was found. Therefore, no general trend can be identified. Whenever there was moisture in the sponge, moisture was not a critical factor. However the user of the holiday detector should know that, while ordinary tap water would suffice to wet the sponge on a coating up to 10 mils thick, a non-sudsing wetting agent should be used for thicker coatings. The idea is that moisture should be able to penetrate any possible voids in the thicker coating and sudsy aqueous liquids will increase this ability. The manufacturers of the holiday detectors suggest Kodak Photo-Flo R as an acceptable wetting agent. The manufacturer, however, emphasizes the need to make several passes with the sponge electrode to assure that moisture has penetrated all existing voids.

Another critical factor when using a holiday detector is signal adjustment. This factor was not considered in this study, but it is important when testing bars with coatings thicker than 10 mils. The detector's signal is usually factory set to trigger at an external resistive load of 80,000 ohms  $\pm 5\%$ , which is the standard for coating up to 10 mils thick. To accommodate coatings in excess of 10 mils, the sensitivity of the device needs to be adjusted. A signal actuation load of 100,000 ohms is adequate for coatings up to 20 mils thick.

Generally, a slower operating speed led to more responses. The deviation of responses obtained at different detection speeds for the same region of the bar was large. What complicates the problem of having consistent responses is that a long signal may be treated as two or more short signals due to different operating speeds and different orientations of the sponge which may, occasionally, lose contact with the bar. It is worth

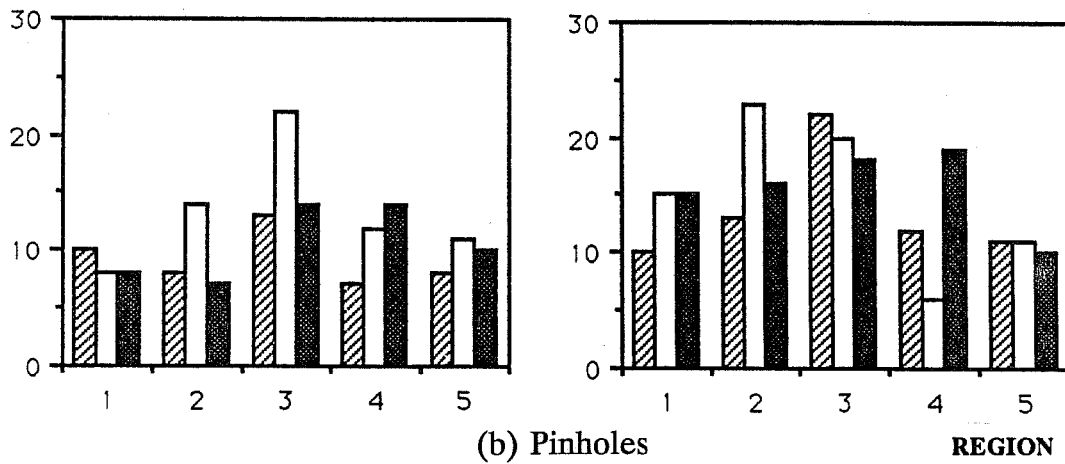
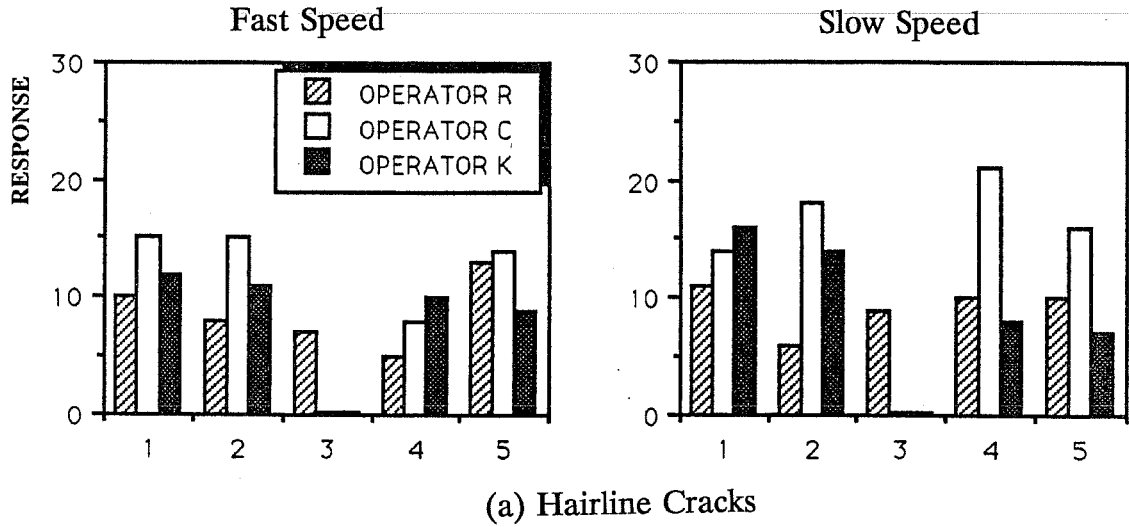

Figure 2.10 Total response using a holiday detector with wet sponge, #8 bars with cross deformations, Variable Operators.

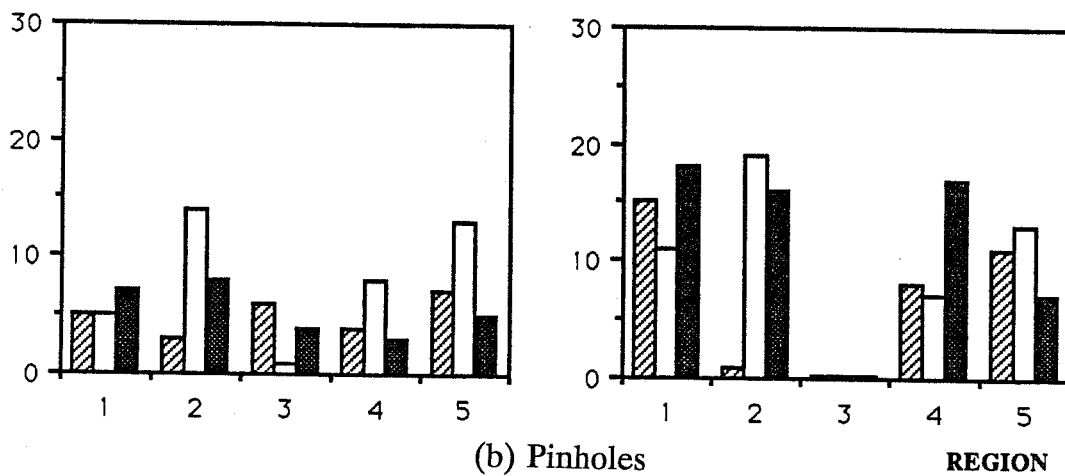
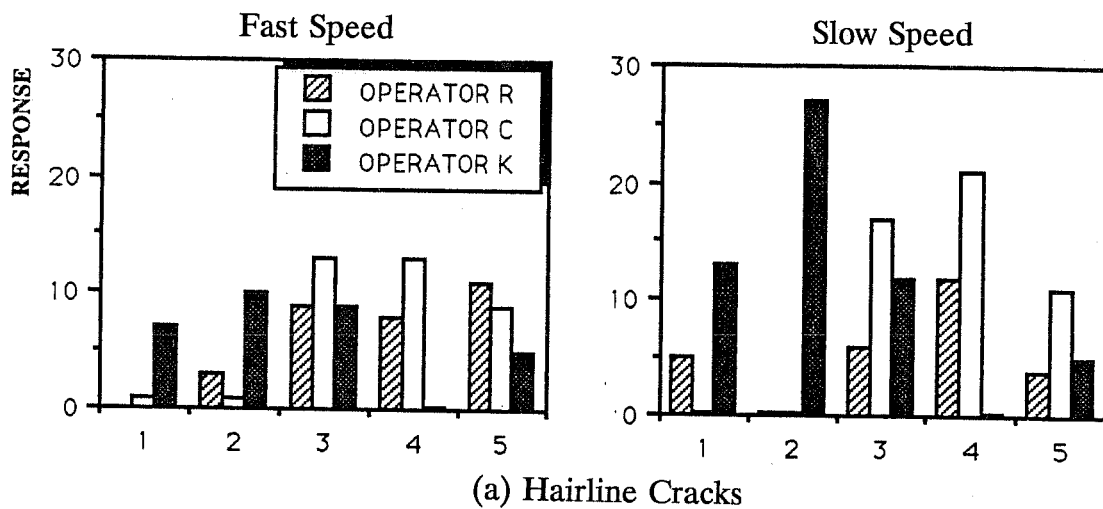

Figure 2.11 Total response using a holiday detector with wet sponge, #4 bars with parallel deformation, Variable Operators.

noting here, that such a problem is especially cumbersome when inspecting bent bars. The inner and outer radii of bent bars usually have a large number of closely-spaced damage spots which are hard to detect separately.

The response distributions were generally dissimilar for different operators. Therefore, the number of signals counted may not accurately reflect the number of possible voids in the coating. Each operator detected the bars differently and used different judgment regarding the number of signals heard.

Based on the above, a holiday detector generally cannot be considered a reliable device for detecting voids or pin-holes in epoxy coating applied to steel bar surfaces. However, the general quality of the coating can be evaluated by careful holiday detection accompanied by visual inspection. In the study reported here, the number of responses obtained can only indicate possible defects in the coating. The readings gave no indication of the location and the size of existing defects.



## CHAPTER 3 IMMERSION TEST OF BENT BARS

### 3.1 Introduction

It has been stated earlier that the performance of epoxy-coated reinforcement depends heavily on the quality of coating applied. When surrounded by concrete, the epoxy-coated bars are provided with a protective environment of hydrated cement compounds. However, corrosion of coated bars may still occur, possibly to a lesser degree compared to uncoated bars. According to a large number of published research papers, the real corrosion mechanisms of epoxy-coated reinforcement in concrete are not yet well understood. This is due in part to the fact that corrosion activities below the concrete surface are difficult to monitor. In most cases where corrosion of epoxy-coated bars has occurred, it has been observed that corrosion initiated at breaks in the coating and spread to some extent underneath the coating (undercutting). When this happens, the epoxy coating is rendered ineffective and subsequent loss of adhesion is expected.

Emphasis has been put on producing epoxy-coated reinforcement free of defects and damage and on delivering it to the job site in excellent condition. However, fabrication of bars almost always produces damage to coating. Even with the most careful bending process, damage cannot be totally avoided. It is, then, prudent to scrutinize the fabrication process to identify deficiencies and potential sources of damage to coating. Knowing the problematic activities and their consequent damage to coating, the effects of such damage on the long term performance of coated bars can be experimentally investigated. Based on the findings, recommendations on how to minimize damage and to what extent will then be developed.

Bending of epoxy-coated bars is usually completed at the coating plant. For greater efficiency, the bars are often bent at a fast rate. Unfortunately, this practice is unfavorable because it may cause damage to the coating. In addition, the coating on the bent portion of the bar is often subjected to scraping or compression damage unless special precautions are taken. If the bending mandrel is not properly padded with an appropriate material at specific points, a considerable amount of damage on the inside portion of the bend results. Damage on the inside of the bend is nearly always neglected. Current specifications do not explicitly address this kind of damage. On the other hand, there are specified limits for damage on the exterior radius of the bend.<sup>6</sup>

According to ASTM D3963 specification, damage needs to be repaired with a patching epoxy material compatible with that used to coat the bar if the percentage of the total damaged area to the total surface area per unit foot is over 2% or any damage spot has a size greater than 1/4 in. x 1/4 in. The area patched is limited to 5% of the total surface area. If this limit cannot be satisfied, the bar should be rejected.<sup>11</sup> The Concrete Reinforcing Steel Institute (CRSI) has published recommended guidelines in full agreement with the above specified limits on damage

to coating that requires patching.<sup>6</sup> These guidelines were the basis of the following experimental study focusing on assessing the relative performance of coated bars damaged to various degrees. The test used for this study is an immersion test in which the prepared bars are subjected to a very corrosive environment to accelerate corrosion. Recent discussions regarding repair of damage indicate that patching requirements will be stricter in the future.

### 3.2 Control Variables

Bars of two different sizes – #4 and #8 – were tested. A series of nine groups for each bar size was tested and denoted either A for #4 bars or B for #8 bars. For each group, three replicates were included. In order to reduce the variations that might occur in the test, all bars were taken from the same lot of reinforcement. These bars were cut and bent to the required size and shape before subdividing them in various groups. The average thickness of coating of bars in a group was not different from group to group.

All bars were bent 180° using a bending machine at the coating plant that had high density plastic sleeves over metallic mandrels. Figure 3.1 shows the configuration and dimensions of these bars. After bending, further damage to coating was purposely introduced at the outer radius to reach the limiting percentages of damage set for testing. The bars were grouped according to these different percentages of damaged area to the total surface area. For some of the groups, damaged areas were patched using a compatible epoxy repair material specified by the manufacturer of the epoxy coating material. For these patched bars, similar bars with identical damage but without patching were also used. Companion bars of all tested bars were also embedded in small concrete blocks and subjected to alternate wetting and drying exposure cycles for observation over a longer period of time. These tests, called macrocell tests, will be reported later, after they have been subjected to exposure cycles over a period of 1 to 2 years.

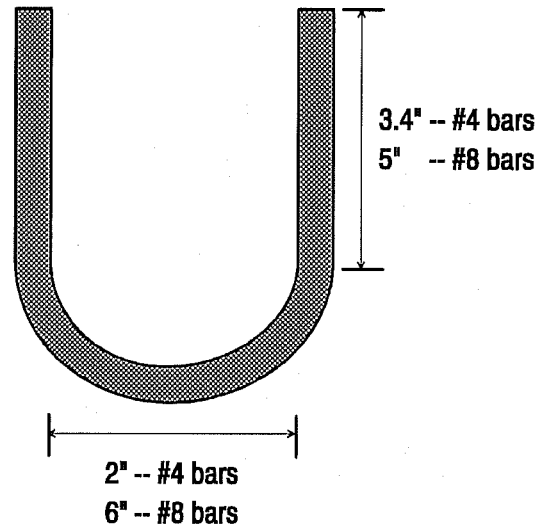

Figure 3.1 Configuration and dimensions of bars used in the immersion test.

Table 3.1 shows the variables included in the immersion test. The different damage levels and condition with respect to patching for bars incorporated in both A and B groups are disclosed. Two types of bar deformation patterns were included, namely the parallel



Table 3.1 Immersion Test Variables for Series A and B Bars.

Group Number For A and B Series		Damage Level - Size or Percentage†	Patching Condition
A1	B1	Control black bars	--
A2	B2	Damage spot of size > 1/4 in. x 1/4 in.	With patching
A3	B3	Damage spot of size > 1/4 in. x 1/4 in.	Without patching
A4	B4	Small damage spots > 2%	With patching
A5	B5	Small damage spots > 2%	Without patching
A6	B6	Small damage spots or cracks < 1%	Without patching
A7	B7	Small damage spots < 2%	Without patching
A8	B8	Control black bars	--
A9	B9	Damage spot of size > 1/4 in. x 1/4 in.	With patching
A10	B10	Small damage spots > 2%	Without patching
A11	B11	Small damage spots < 2%	Without patching

Note: Series A = #4 bars; Series B = #8 bars; Groups 1 - 7 have parallel deformations; Groups 8 - 11 have cross deformations  
†Area damaged/total area immersed

deformations and the cross deformations. Furthermore, two control groups of uncoated bars were used for comparison in each series.

For most of the bars, the damage was introduced deliberately. A utility knife was used to peel off the coating to create the required damage level. In computing the percentage of damage, that part of damage due to bending on the inside portion of the bend was included. The damaged area was measured and divided by the total surface area immersed to obtain the percentage of damage.

Table 3.2 shows the damage levels in two other series, C and D. These series include #4 bars with parallel deformations coated with materials from different suppliers. The configurations and dimensions of these bars are the same as those of series A. The bars in series C and D were bent in the laboratory using plastic rings over the mandrels to prevent damage to the coating on the inside of the bend (shown in Figure 3.2).

Table 3.2 Immersion Test Variables for Series C and D Bars.

Group Number For C and D Series†		Damage Level Percentage‡	Patching Condition
C1	D1	Small damage spots > 2%	Without patching
C2	D2	Small damage spots > 2%	With patching
C3	D3	Small damage spots < 1%	Without patching

†Series C and D bars were coated with different epoxies than that used for Series A and B bars  
‡Area damaged/total area immersed

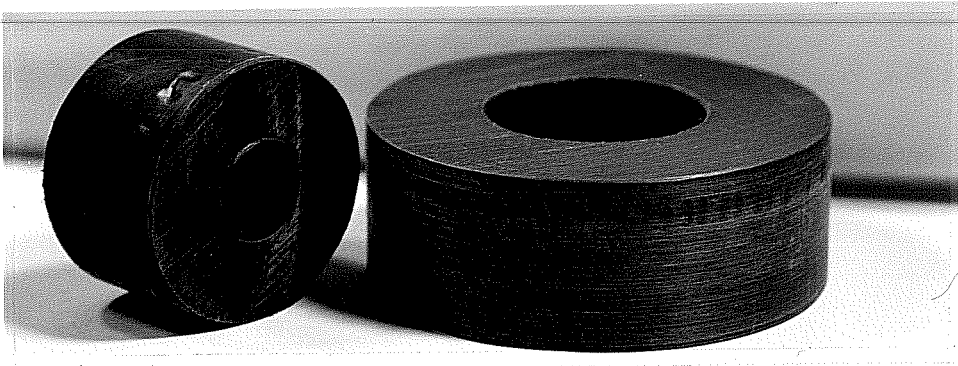

(a) Protective plastic rings

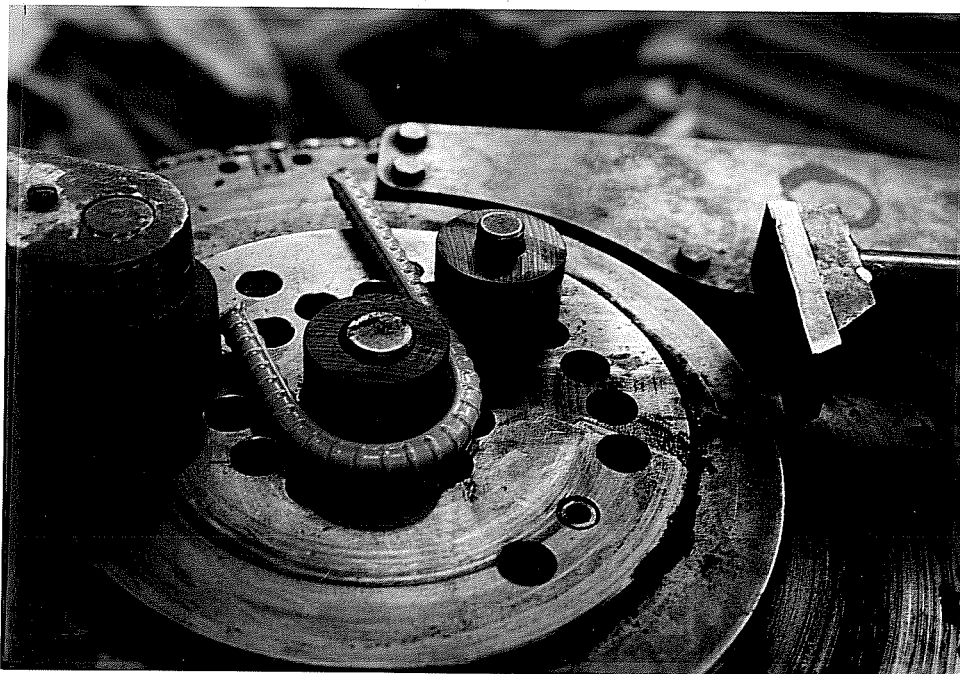

(b) Bending with protective rings over the mandrels

Figure 3.2 The protective plastic rings used for bending epoxy-coated bars.

With the protective ring and using a slower rate of bending, there was almost no damage to the inside portion of the bend. Figure 3.3 shows two bars: one bent in the laboratory with a protective plastic ring and another bent at the coating plant. As can be seen, the bar bent at the coating plant suffered far more damage on the inside portion of the bend than the other bar. The difference in the amount of damage could be attributed to variations in plastic density, bending rate and coating material.

### 3.3 Test Setup and Procedures

In order to observe and investigate corrosion behavior of epoxy-coated reinforcement, the epoxy-coated reinforcing bars were placed in a salt solution and cycled through periods of immersion and drying. Although this environment was not the same as the one that epoxy-coated reinforcing bars are usually subjected to while in service, the results of the test were still indicative of corrosion behavior. The test provides a means for a quick examination of the effectiveness of the epoxy coating in a severely corrosive environment.

In order to prevent further damage to the coating during testing, the bars were hung from a wooden frame using nylon strings and submerged in a 3.5% NaCl solution. The frame was built to permit lifting the bars out of the solution during the drying portion of the exposure cycle. The bars were suspended above the saltwater level so that any solution on the bars would drop into the immersion bucket. To account for the possible evaporation of water, a constant concentration of the solution was maintained by adding water to a fixed depth. Figures 3.4 and 3.5 show the test setup.

### 3.4 Observations of the Immersed Bars

The uncoated bars, as well as the damaged areas on the coated bars started to corrode immediately after submersion in the salt solution. Brown corrosion products were observed accumulating on the surfaces of the damaged areas. Both the inside and outside portions of bends were similar in their behavior.

The patched areas showed no signs of corrosion for the first few weeks, but then corrosion was evident at the patches. At first, the patched surface was smooth and shiny. With time, bubbles and brown spots developed, and then the coating where the bubbles formed started to break down. At this stage, corrosion was accelerated as saltwater penetrated the damaged coating. After 8 months of immersion, a considerable amount of corrosion products had accumulated on the patched areas. Figure 3.6 shows a typical progression of corrosion in the patched areas. The dark colored area is the patched area.

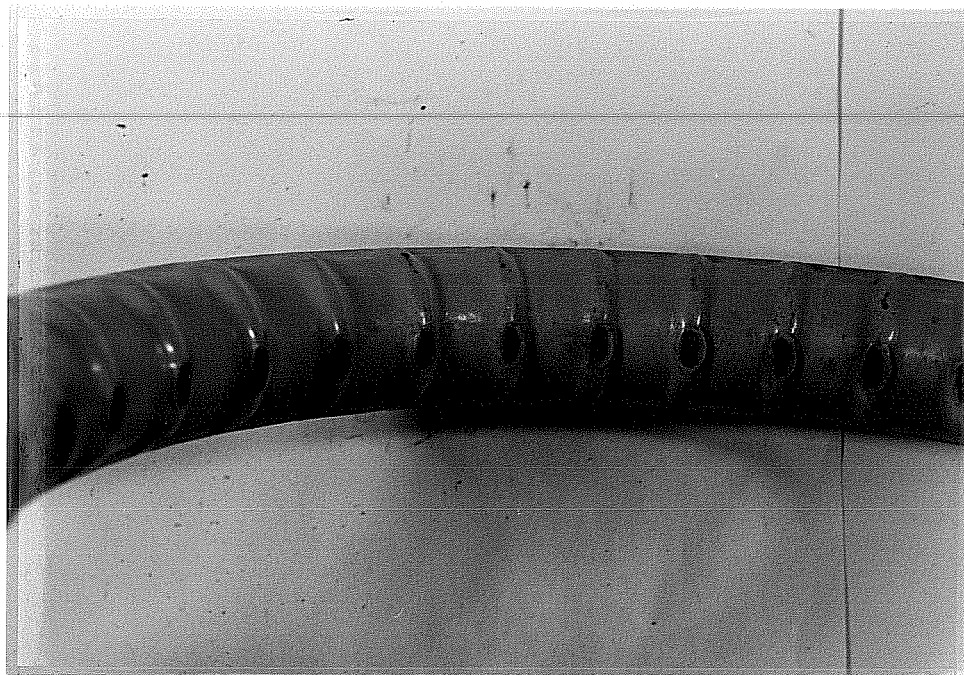

(a) A bar bent at the coating plant

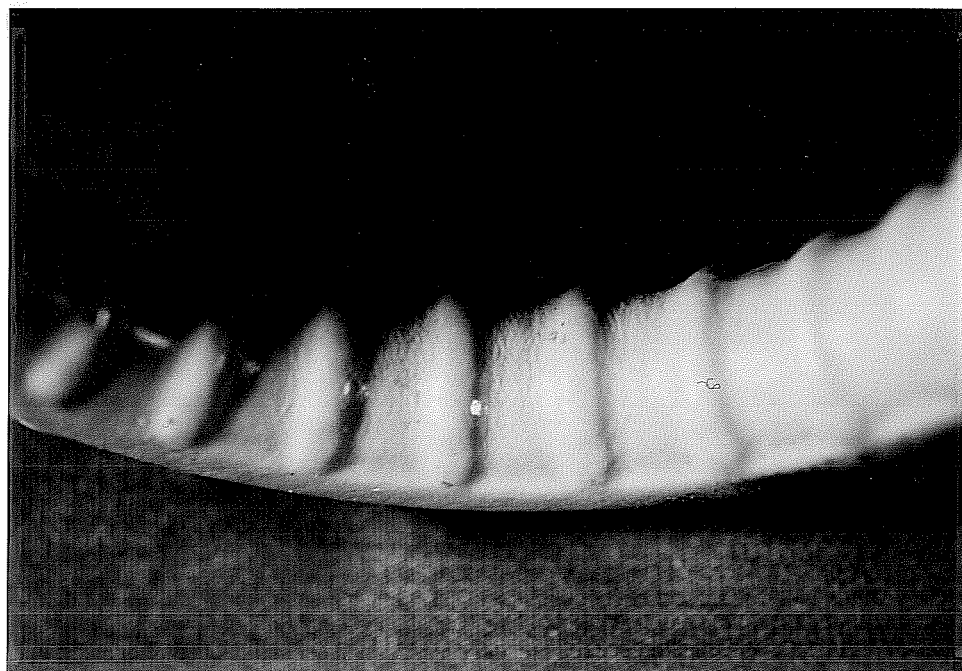

(b) A bar bent in the laboratory

**Figure 3.3 Comparison of damage induced by different bending operations.**

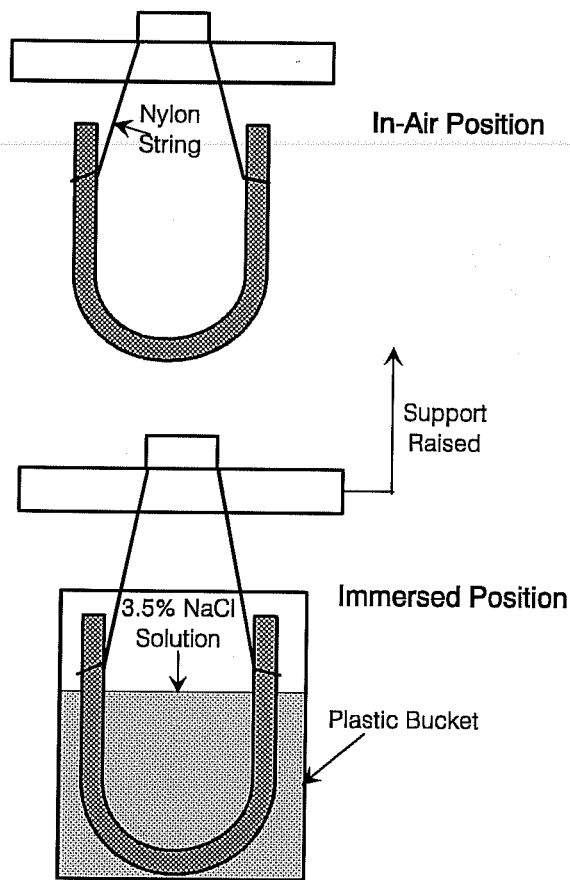

Figure 3.4 Schematic setup of the immersion test.

Signs of corrosion were evident on the bars where damage had been introduced. Conspicuous brown corrosion products accumulated on the damaged areas. Figure 3.7 shows the progression of corrosion in the damaged areas after 8 months of testing. It can be seen that corrosion was severe and a considerable amount of corrosion products built up on the surface.

Considerable corrosion was also observed in the damaged areas on the inside portions of bends. The amount of damage caused originally by bending varied according to deformation type. Usually bars with cross deformations had more damage than those with parallel deformations. The areas damaged gradually increased toward the free end of the bent portion. Figure 3.8 shows the damaged areas of both deformation types and the progression of corrosion in these areas, again after 8 months of testing. The accumulation of corrosion products in damaged areas indicate clearly that the inside portions of bends are as susceptible to corrosion as the outside portions, even though it may appear that the coating has only been compressed.

Bars in series C and D had almost no damage on the inside portions of the bends. Therefore, very little corrosive activity can be seen in these areas. However, the rest of the bars show corrosion patterns very similar to those for bars in series A and B (shown in Figure 3.9).

Corrosion not only began in the damaged areas that had been introduced deliberately but also started on the holidays in the coating that were not detected in advance. Holidays, by definition are pinholes invisible to the unaided eye. Corrosion on the holidays was evident from small brown spots scattered along the bar. Figure 3.10 shows this type of corrosion. It is evident that most of the holidays were located on the deformations or along their sides. Some of the holidays were located around the patched areas.

In general, more corrosion on holidays was observed on bars with cross deformations, than on bars with parallel deformations. Most of the holidays existed along the sides of the lugs. These are areas where coating is usually difficult to apply uniformly. Therefore, holidays tend



(a) "Immersed" position



(b) "In-air" position

Figure 3.5 Experimental setup of the immersion test.

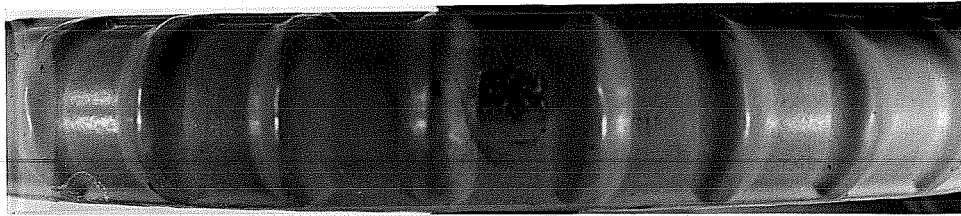

(a) After four months



(b) After five months

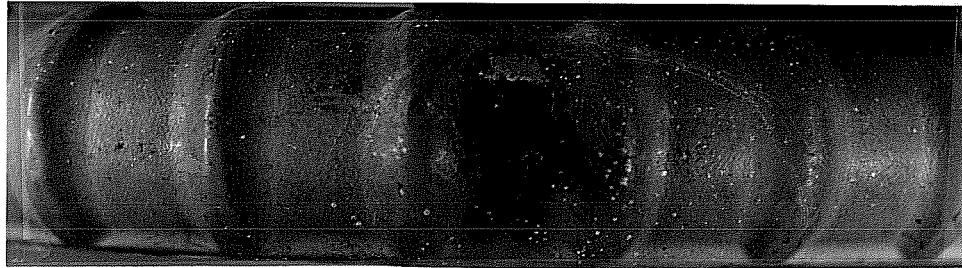

(c) After eight months

**Figure 3.6 Progression of corrosion in the patched area of a bar in Group B2**

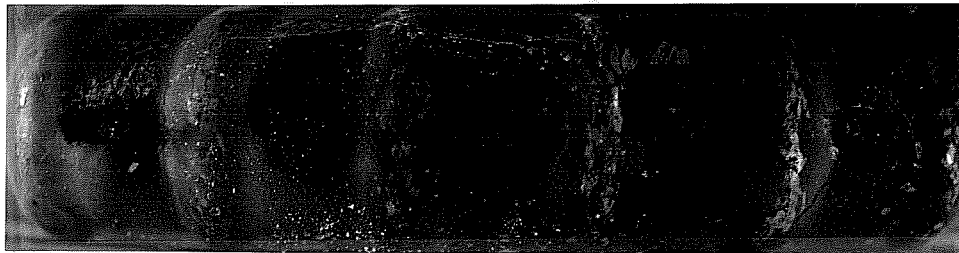

(a) #8 bar with > 2% damage level (B5 group)

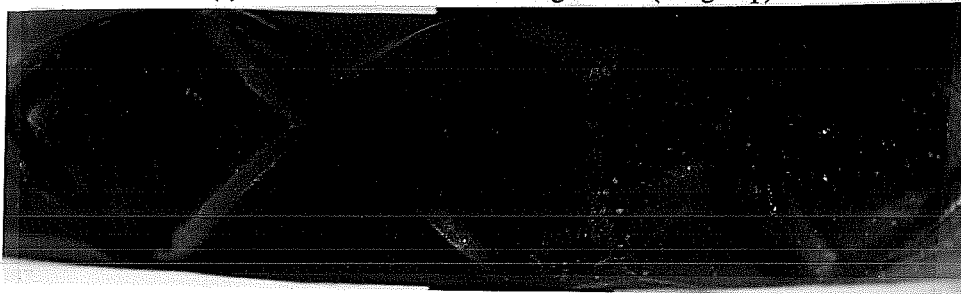

(b) #8 bars with > 2% damage level (B10 group)

**Figure 3.7 Progression of corrosion in the damaged areas.**



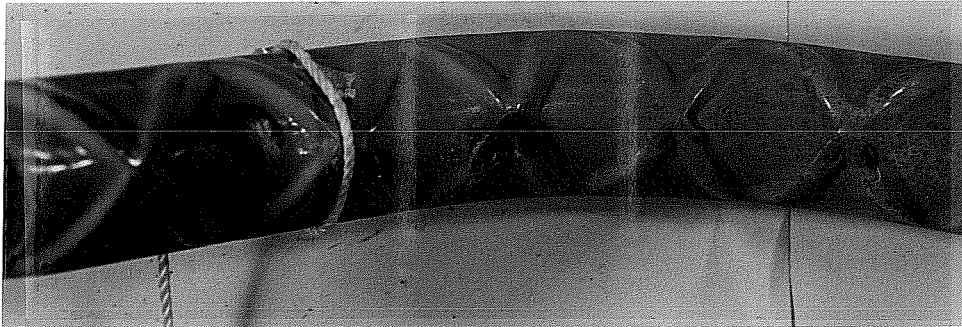

(a) A bar with cross deformations

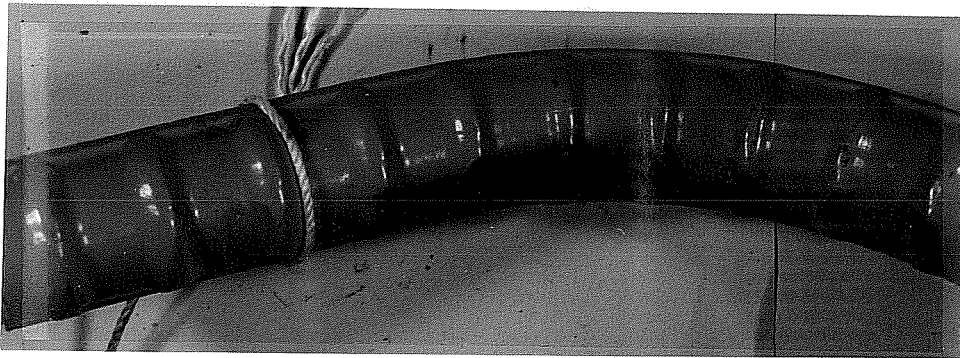

(b) A bar with parallel deformations

**Figure 3.8 Corrosion in the damaged areas on the inside portions of bends**

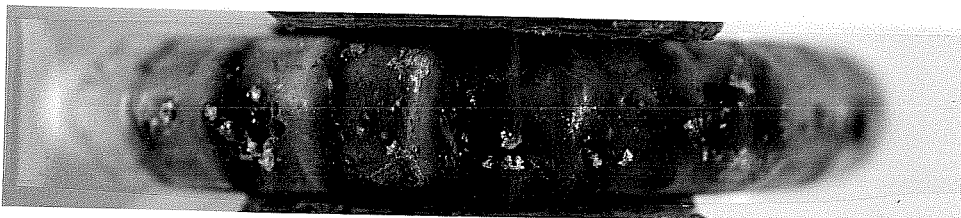

(a) Corrosion in patched areas

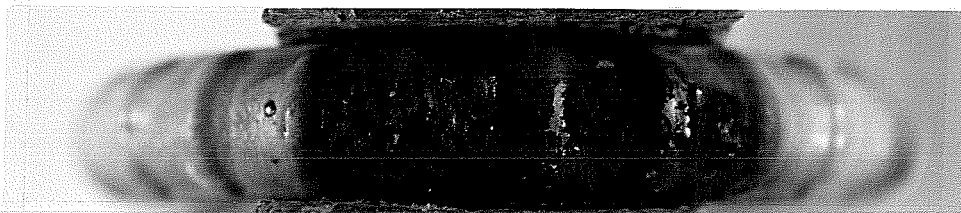

(b) Corrosion in exposed areas

**Figure 3.9 Typical corrosion observations of bars in series C and D.**



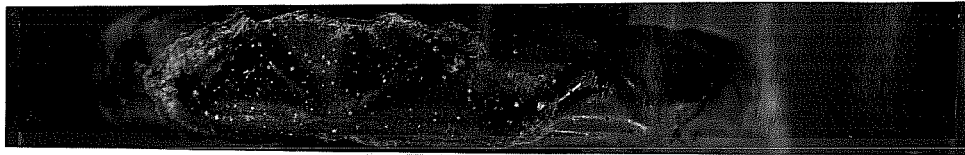

(a) #4 bar (A11 group)

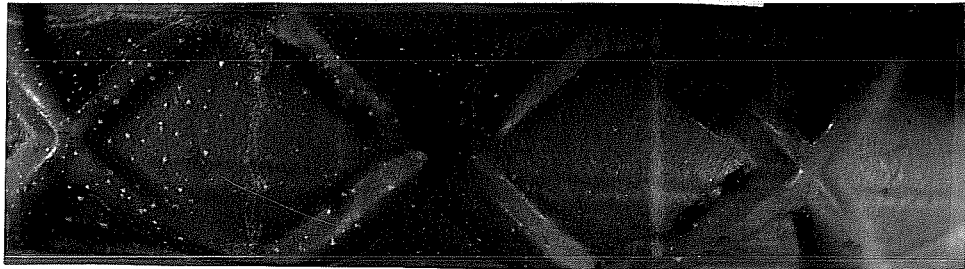

(b) #8 bar (B9 group)

Figure 3.10 Corrosion on holidays (small pinholes)

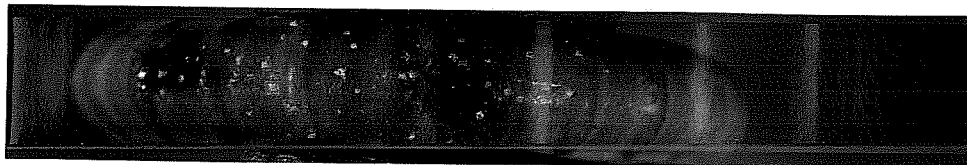

(a) #4 bar with parallel deformations (A2 group), one pinhole to the right of the patched spot



(b) #4 bar with cross deformations (A9 group), few pinholes around and to the left of the patched spot

Figure 3.11 Comparison of corrosion on holidays on bars with different deformation patterns but with the same introduced damage.

to concentrate more in these areas than elsewhere. Cross deformations are more complex than the parallel deformations and, hence, are more prone to have holidays. Figure 3.11 supports this observation, showing a larger number of brown spots on bars with cross deformations, than on bars with parallel deformations. However, the variation in performance of bars with different deformation patterns may also depend on many other factors such as the coating operation, the coating thickness, and the ability of the coating to "stretch" without breaking during the bending operation.

Hairline cracks at the intersection of sides of the lugs with the bar are very common on the outside portions of the bent bars. Such cracks occur as a result of stretching the coating beyond its limit when bending the bars. The adhesion of the coating along the sides of the lugs is, perhaps, the weakest considering the angle of change in geometry of the bar surface. Figures 3.12 and 3.13 show corrosion activity at hairline cracks. It was evident that the size of the bar has an influence on the formation of hairline cracks. The #8 bars showed fewer cracks and less corrosion at the lug/bar intersection compared to #4 bars. The tighter bending radius of #4 bars is likely the main reason for developing more cracks in the coating. The bending radius was  $4d$  (or 2 in.) for #4 bars compared to  $6d$  (or 6 in.) for #8 bars. The type of deformation also affected the formation of cracks. Bars with parallel deformations exhibited more hairline cracking along the lugs.

One interesting phenomenon observed is that as the damaged area decreased, holiday or hairline crack corrosion increased. It can be seen from Figure 3.14 that more intensive holiday corrosion occurred on bars with smaller damaged areas. The same phenomenon was observed on the inside portion of the bend where corrosion activity increased as the introduced damage on the outside portion decreased (see Figure 3.15). One possible explanation is the unfavorable area ratio effect. This is an important factor in galvanic corrosion which refers to the ratio between the cathodic and anodic areas. An unfavorable area ratio consists of a large cathode and a small anode. For a given current flow in a corrosion cell, the current density is greater for a small corroding electrode than a large one. The greater the current density in an anodic area, the greater the corrosion rate.<sup>10</sup> For the bars tested, the damaged areas most likely served as both the anodes and the cathodes, i.e. forming microcorrosion cells. It may happen, however, that the electrolytic solution gets under the coating, through damaged areas, triggering cathodic reactions on a greater surface area and concentrating anodic reactions on the exposed damaged areas. In this case, a smaller anodic proportion leads to more severe corrosion.

Another possible explanation is that larger damaged areas tend to be more anodic than smaller ones (such as holidays), thereby forcing the latter to be less active. When no such large areas exist, pinholes or the like become the prime anodes. This explanation is due to the fact that large exposed areas have more chances to create anodes. Once corrosion is initiated in these areas, the potential difference is increased between them and the surrounding bar. The electrochemical activity at small damaged areas become less promoted.



(a) #4 bar (A6 group)

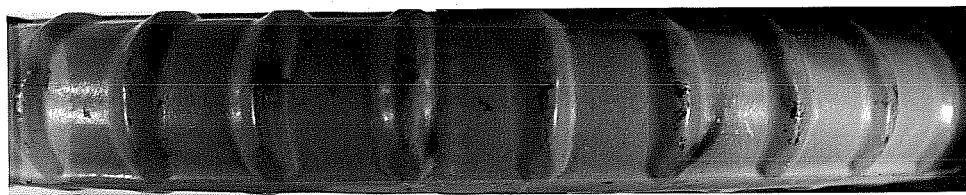

(b) #8 bar (B6 group)

Figure 3.12 Corrosion on hairline cracks on bars with parallel deformations.



(a) #4 bar with parallel deformations (A3 group)

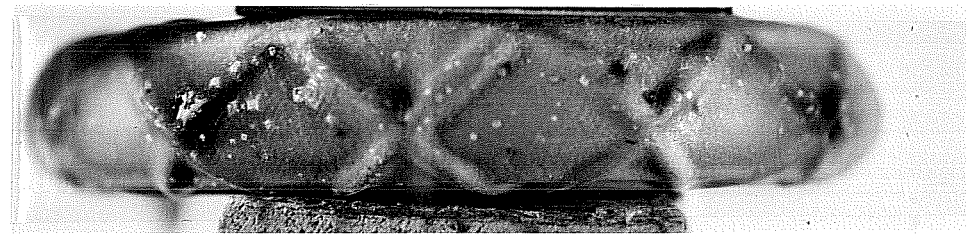

(b) #4 bar with cross deformations (A11 group)

Figure 3.13 Comparison of corrosion on hairline cracks on bars with different deformations.

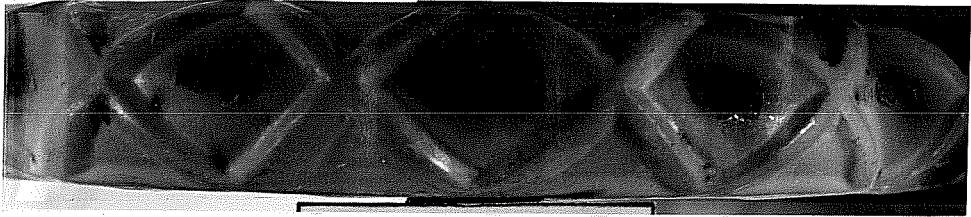

(a) Damage area > 2% (B10 group)

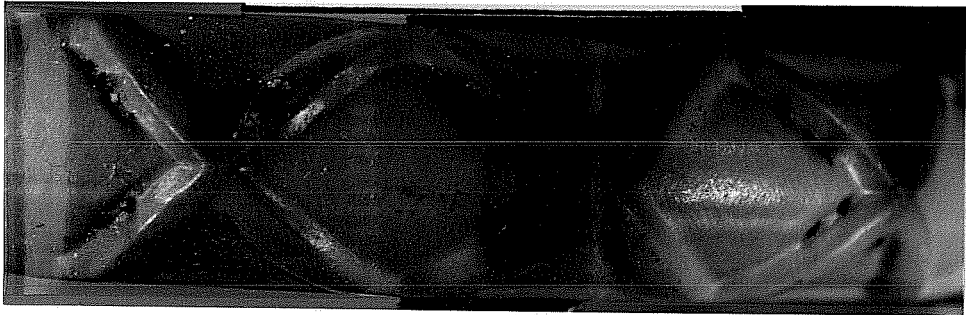

(b) Damage area < 2% (B11 group)

Figure 3.14 Comparison of corrosion on holidays for different damage levels

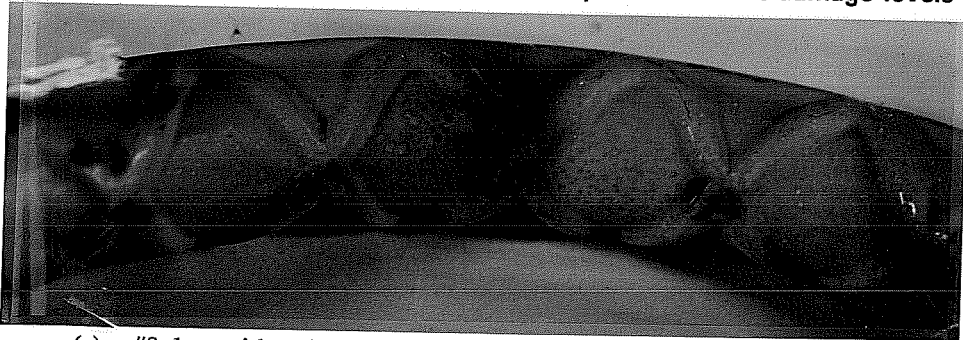

(a) #8 bar with a damage spot > 1/4 in. x 1/4 in. which is < 2%

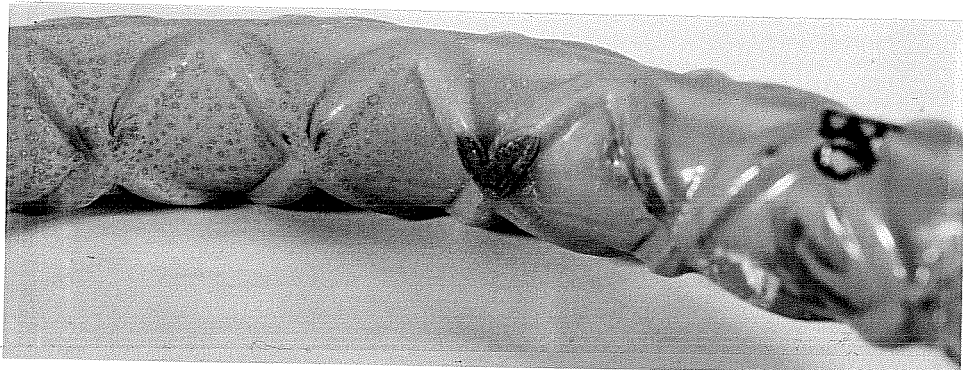

(b) #8 bar with damage area > 2%

Figure 3.15

Comparison of corrosion on the inside portion of bend for different introduced damage on the outside portion.

For comparison, the uncoated bars corroded severely with considerable rust buildup on their surfaces. Bar features, such as deformation lugs, were degrading. The severity of the corrosion activity was far more on uncoated bars than on coated bars.

### 3.5 Investigating Under the Coating

The coating of selected bars was peeled off in order to investigate the extent of corrosion propagation. By inspecting the surface condition under the coating, the severity of corrosion was qualitatively evaluated. Following are the general observations documented during coating removal after 8 months of testing.

Coating on the bend peeled off much more easily than that on the straight portion. Bar size and deformation type also affected the ease or difficulty of coating removal. Generally, the coating on #8 bars with parallel deformations was the easiest to remove. The greater loss of coating adhesion on the bent portion may be the result of either the bending operation ("stretching" of the coating) or corrosion (undercutting). In all cases, the epoxy-coating was more difficult to remove before immersion testing than afterward. This strongly indicates that the coating loses some of its adhesion at the bent portion when exposed to alternate wetting by salt solution and drying, and where corrosion on damage spots will inevitably occur. It seems that adhesion is initially lost because of bending and it continues to deteriorate as corrosion develops with time. As the bar is bent, the coating is stretched and permanently thinned. Permeation of the coating by aqueous solutions becomes easier leading to disbondment or loss of adhesion. This, together with the adverse effect of corrosion causes a detrimental loss of adhesion on the bent portions. However, these are only subjective observations and have not been quantified by any monitoring scheme.

Under the coating, signs of corrosion can be detected by a dark brown color on the surface of the bar. Figure 3.16 shows surface conditions of several bars after the coating was removed. It can be seen that corrosion penetrated under the coating at least 1/4 in. from the edge of the damaged area. Corrosion brown spots spread on the steel surface mainly where damage or loss of adhesion occurred as shown in Figure 3.17. On the inside of the bend where consecutive damage spots existed, areas of corrosion were continuous; the progression of corrosion under the coating was very extensive (see Figure 3.18). There was, literally, no noticeable difference between the severity of corrosion under the coating on the outside or inside portions of the bends.

Generally, the adhesion of the coating along the straight portions of the bars was good as long as no damage spots or signs of corrosion were evident on the coating. The bar surface under the coating was mostly shiny and clear of the tiny brown spots, indicating the steel was free of corrosion.

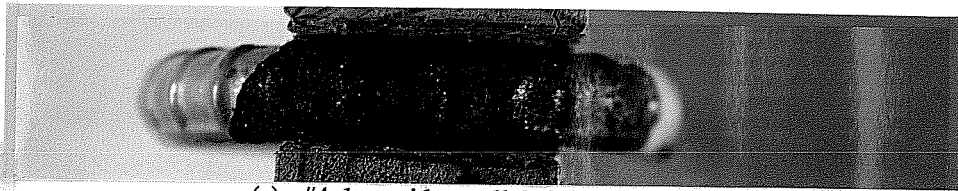

(a) #4 bar with parallel deformations

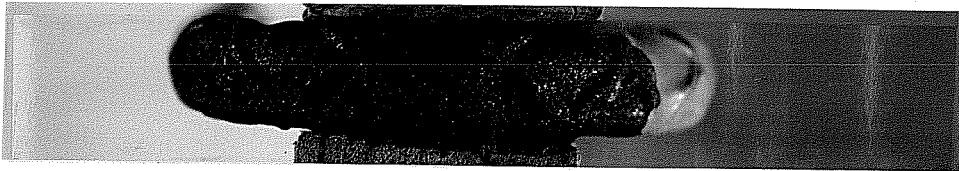

(b) #4 bar with cross deformations

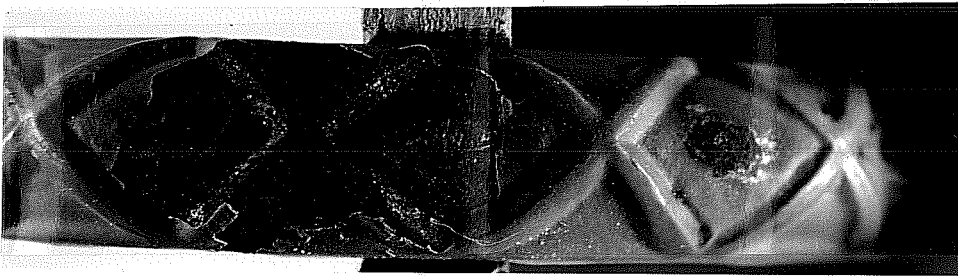

(c) #8 bar with cross deformations

**Figure 3.16 Corrosion propagation under the coating**

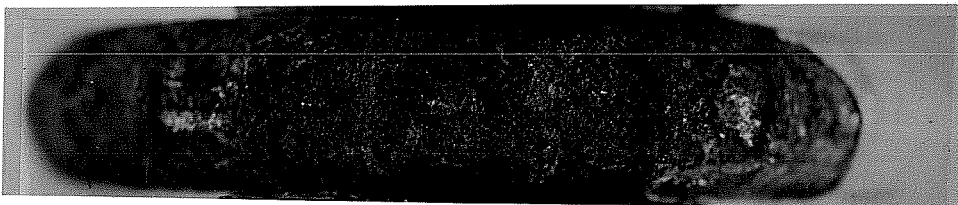

(a) #4 bar with damage area  $> 2\%$  (A7 group)



(b) #4 bar with damage area  $< 2\%$  (A11 group)

**Figure 3.17 Corrosion spots under damaged or disbanded coating.**

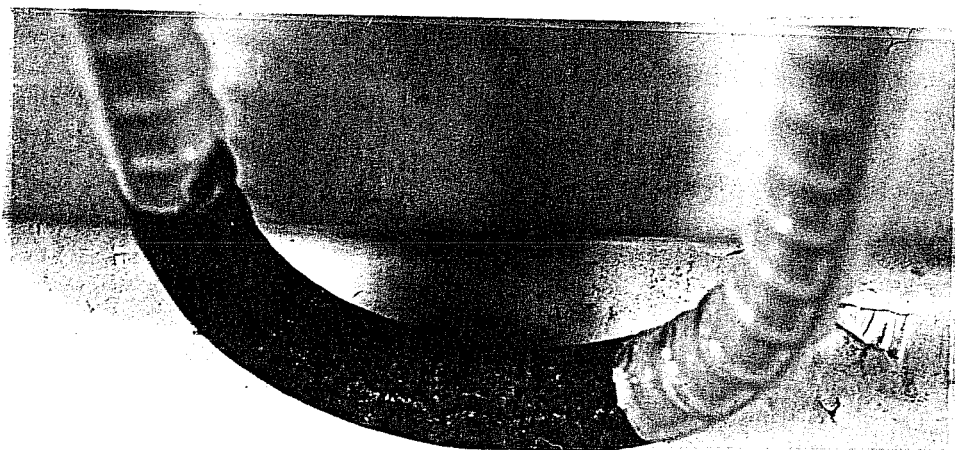

(a) The inside of bend of the bar shown in Figure 3.16(a)

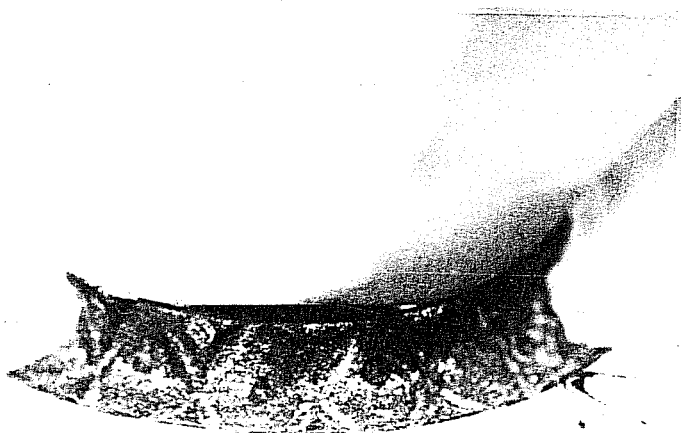

(b) The inside of bend of the bar shown in Figure 3.16(b)

Figure 3.18 Corrosion progression on the inside of bends.





(a) The inside of bend of the bar shown in Figure 3.16(a)

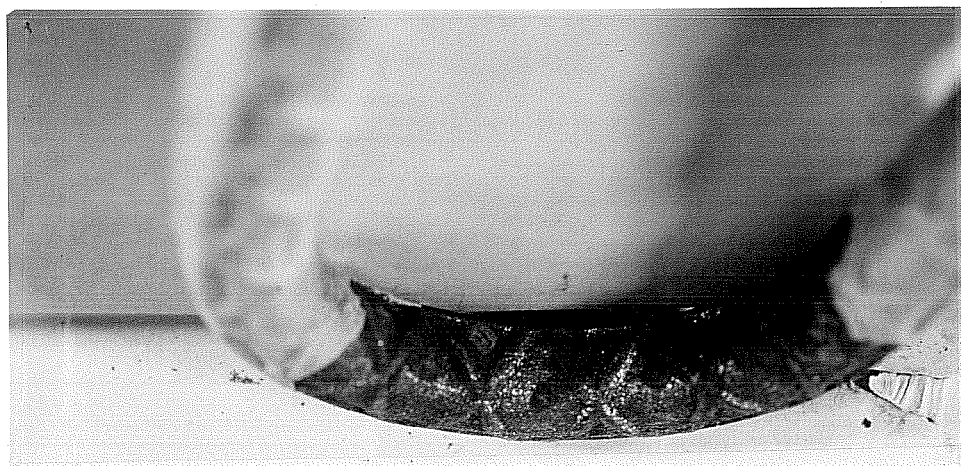

(b) The inside of bend of the bar shown in Figure 3.16(b)

**Figure 3.18** Corrosion progression on the inside of bends.



### 3.6 Conclusions

Based on the above observations, a severe corrosive environment will initiate corrosion on any damage to the coating. No exception is made regarding the size of the damaged area or its location.

Current repair practices for damaged coating proved to be ineffective. All of the areas patched showed corrosion activity after a few weeks of immersion.

Corrosion on small pinholes, cracks, and damaged spots was observed on all of the bars. In addition, it was found that corrosion activity at pinholes and cracks tended to be more severe on bars with smaller areas of introduced damage. Smaller damaged areas led to higher current densities or more negative potentials in small pinholes and cracks, and promoted corrosion in these areas.

Bars with cross deformations were more susceptible to pinhole (holiday) damage than bars with parallel deformations. In general, coating is more difficult to apply uniformly to the sides of the lugs. For bars with more complicated lug patterns such as the cross pattern, the coating on the sides of the lugs appeared to be of poorer quality. As a consequence, cross deformations were more prone to corrosion initiating on coating breaks and holidays.

Corrosion on the damaged spots introduced during bending on the inside of the bends was as severe as on the outside. However, when bars were bent with properly equipped mandrels, corrosion on the inside of the bends was greatly reduced. Therefore, the surfaces against which the bars are bent should be protected to assure that damage does not occur.

Small-size bars (#4 bars) appear to be more susceptible to hairline cracking when bent to a smaller radius than large-size bars (#8 bars). This was especially true for the bars with parallel deformations where hairline cracks along the deformation lugs were very common. Bending epoxy-coated bars to minimum radii should, therefore, be avoided unless required for structural purposes.

Corrosion on control bars was very severe with accumulation of solid rust over the entire uncoated surfaces. Qualitatively, the performance of all damaged epoxy-coated bars was much better than uncoated bars.

The results presented represent conditions after 8 months of testing. The remaining bars in the immersion test are continuing to be subjected to exposure cycles and additional information will be obtained in the future.

## CHAPTER 4

# EVALUATION OF DAMAGE TO COATING DURING CONCRETE PLACEMENT

### 4.1 Introduction

One important result of the immersion test was that even the smallest damage to the coating (holidays) could initiate severe corrosive activities on the bars. The need for damage-free coated bars for corrosion free long-term performance is clear. Consequently, all handling procedures for epoxy-coated bars, especially during construction, need to be examined for any possibility of damaging the coating. In the first chapter, different processes involving handling of coated bars were discussed to identify possible causes of damage to coating. Vibration of concrete during placement is a prime cause of damage that is usually neglected. One reason is that damage due to vibration is not observable and often underestimated. However, it can be particularly detrimental if significant damage occurs on bent bars close to the concrete surface, causing severe corrosion.

Vibration is used to eliminate voids and trapped air while consolidating the concrete in the forms and around reinforcing bars. The vibrator applies periodic force to the concrete with an eccentric rotating mass. The concrete flows (or liquefies) under the force accompanying the vibration, and the concrete is compacted away from the vibrator. Internal or immersion vibrators (often called "spud" or "poker" vibrators) operate at a frequency in the range of 4,000–12,000 rev/min. Internal vibrators are usually preferable in construction. The energy imparted by the head of the vibrator excites the solid particles in the concrete mix, causing it to flow. However, the concrete does not move uniformly. The coarse aggregate particles are propelled from the vibrator head preferentially because of their greater mass.<sup>18</sup>

It is expected that during the consolidation process the vibrator will come in contact with the reinforcement causing damage to the coating. Damage at this stage of construction cannot be inspected or repaired, and it can be a major cause of poor performance in the future.

### 4.2 Test Preparation

A series of three tests were conducted in this phase of the study to examine the damage that may be produced during vibration. The first test simulated a column base with two mats of bars. The top mat consisted of #8 bars and the bottom mat consisted of #4 bars. Each mat consisted of two layers of bars in a perpendicular grid. Figure 4.1 shows the configuration of the form prepared and the arrangement of the bars used. All the reinforcement was epoxy-coated. It was carefully examined and damage prior to placement of concrete was marked. Five vertical #4 bars were positioned as shown in Figure 4.2. These bars were tied to the horizontal

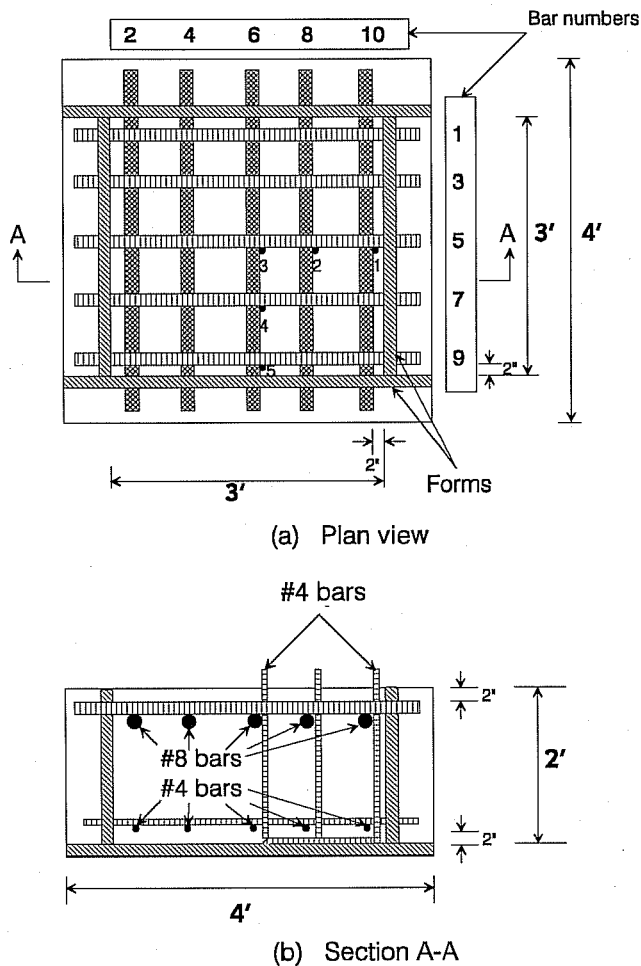

Figure 4.1 Details of the column base specimen.

middle of the form, the vibrator was gradually moved around to consolidate the entire volume of concrete. For the column base specimen, concrete was placed and vibrated in several lifts. When the vibrator was wedged into the space between the cage and the form, it shook violently due to the limited space available. The most critical spaces in all the specimens were the corners where the vibrator had little clearance between the bars and the forms. The concrete was vibrated for a few minutes in the slab specimens and for about 15 minutes in the column base specimen. The concrete was removed promptly and the bars were washed carefully (see Figure 4.10). A thorough inspection was then carried out to document the coating damage due to vibration.

layers of bars by plastic-covered wire to avoid damage during the assembly of the bars (see Figure 4.3).

The second and third tests simulated partial slab sections with one top mat of bars in each specimen. The mat consisted of #4 bars in one case, and #8 bars in the other. The bars were placed at different spacings and in perpendicular directions forming an irregular grid as shown in Figures 4.4 and 4.5. An equal number of bars with parallel deformations and with cross deformations were used in both mats. Again, all the reinforcement was epoxy-coated and was examined in advance for any existing damage. Figures 4.6 and 4.7 show the two slab specimens before placing concrete.

### 4.3 Test Procedure

Concrete was placed in the three prepared forms directly from the ready-mix truck. Figures 4.8 and 4.9 show the specimens during vibration after placing concrete. A 2-in. immersion-type vibrator was used. Starting from the

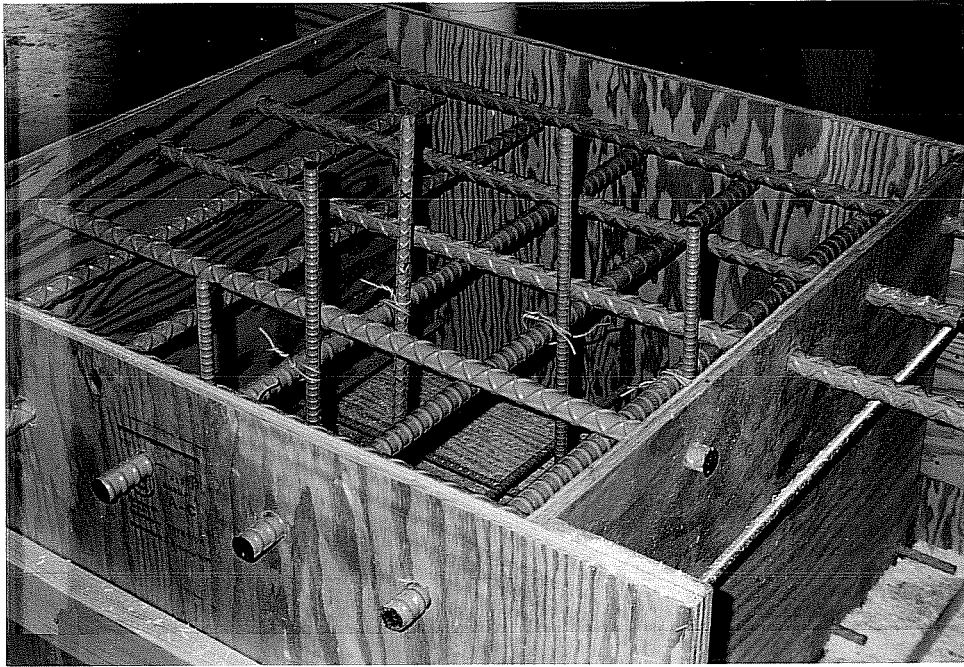

**Figure 4.2 Formwork details of the column base specimen.**

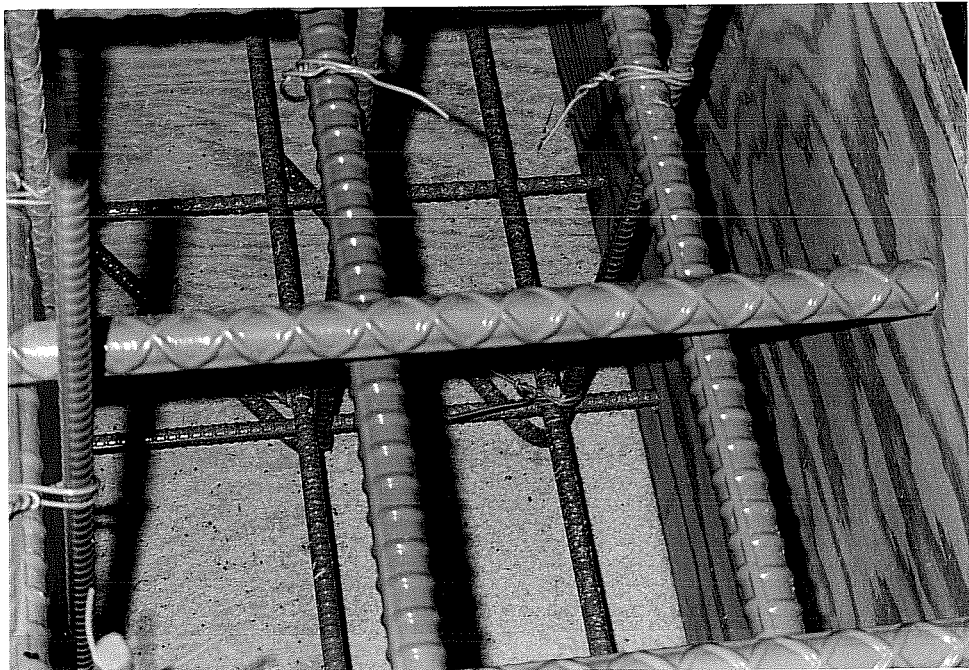

**Figure 4.3 Plastic-covered wire used to tie reinforcement.**

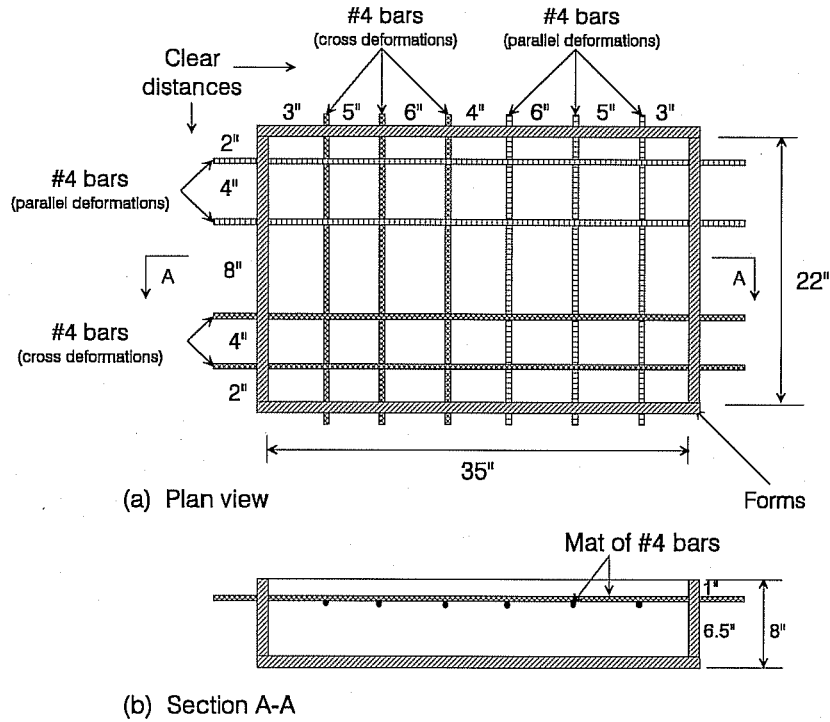

Figure 4.4 Detail of the slab specimen with #4 bars.

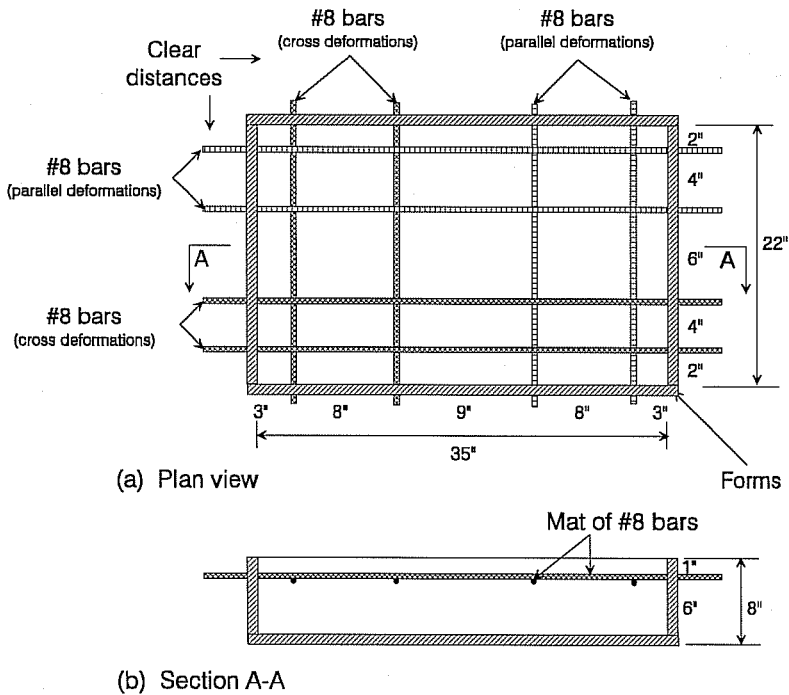

Figure 4.5 Detail of the slab specimen with #8 bars.

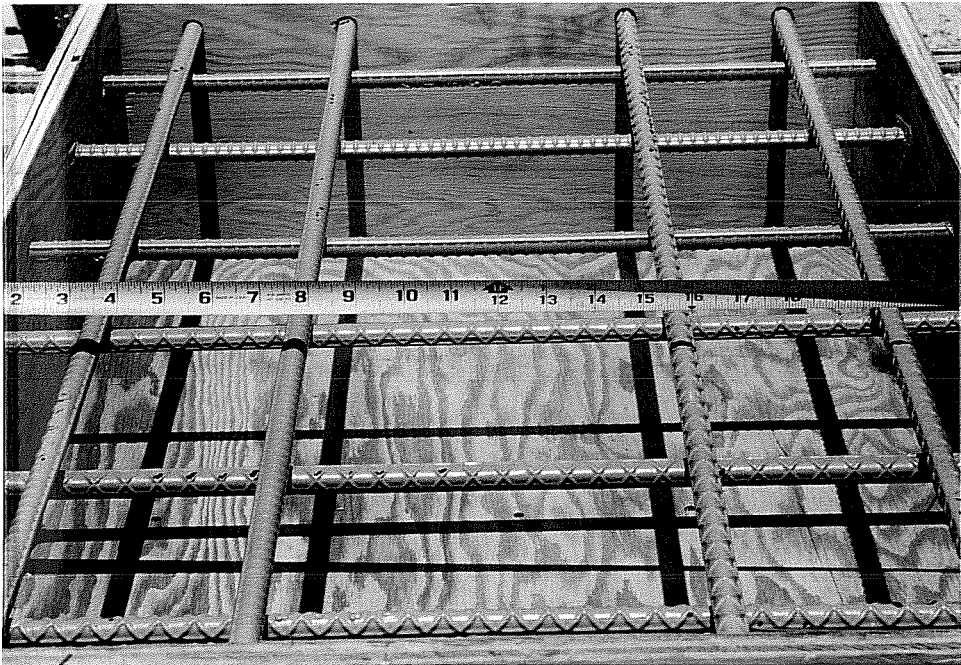
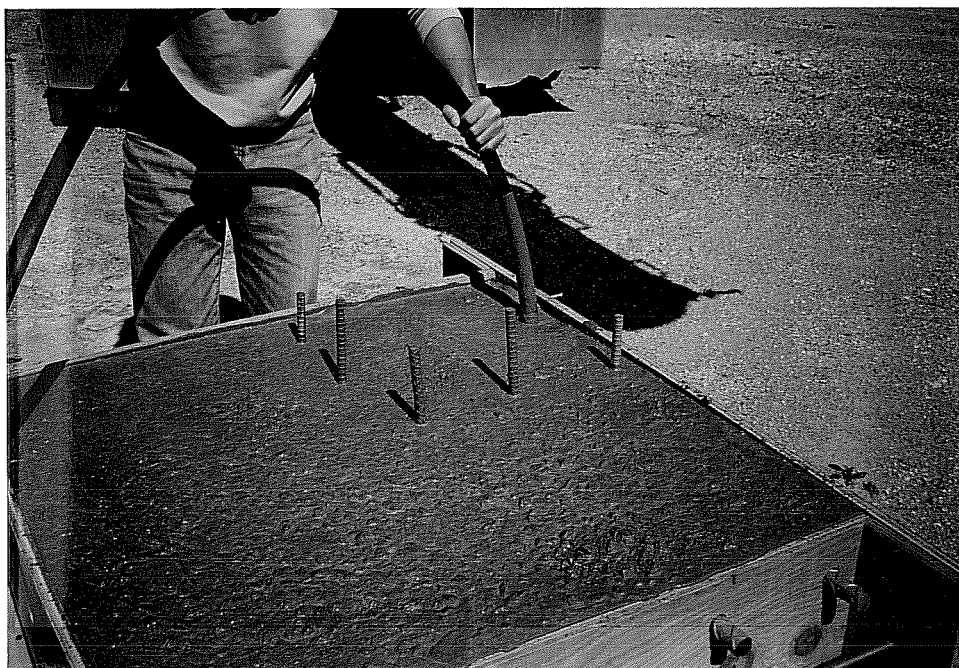

Figure 4.6 Formwork details of the slab specimen with #4 bars.



Figure 4.7 Formwork details of the slab specimen with #8 bars.



**Figure 4.8** Vibration of the column base specimen.



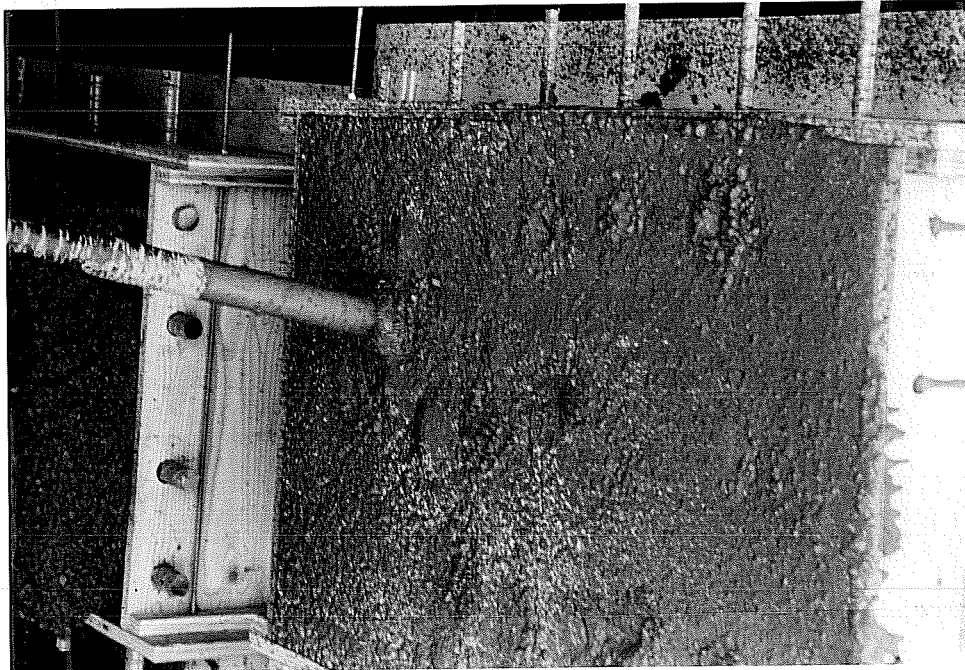

Figure 4.9 Vibration of the slab specimens.

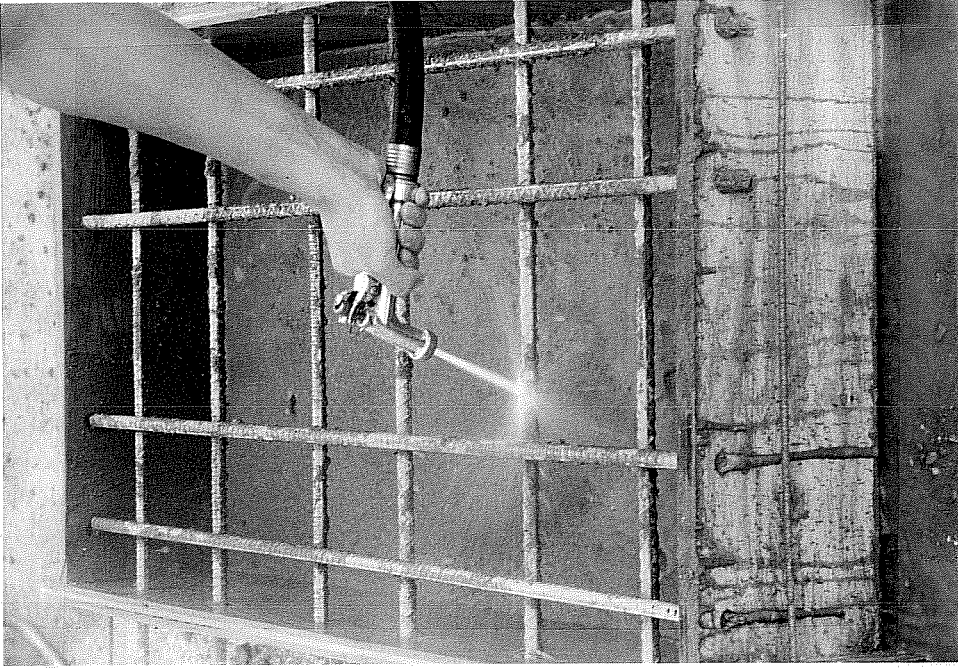

Figure 4.10 Washing the bars after concrete removal.



#### 4.4 Observations of Damage

##### 4.4.1 General Observations.

Damage due to vibration appeared to have been caused by the abrasion between the vibrator and the bars. Bars located along the edges had the worst damage, especially those adjacent to corners.

##### 4.4.2 Column Base Specimen.

Damage caused by the vibrator during concrete placement could be generally identified by the rough surfaces of the coating. Some of these rough surfaces revealed considerable damage in which the bare steel surface had been exposed. The total damaged area of the coating on each bar ranged from 0.1% to 3.0% of the bar surface area. Table 4.1 contains the individual percentages of damage of each bar. The following paragraphs describe damage in detail for the bars according to their locations.

The four bars on the side of the top mat (nos. 1, 2, 9, and 10) were significantly damaged. Several rough areas were observed along each bar. These areas were concentrated at the middle and near the ends of the bars. Damaged spots larger than 1/4 in. x 1/4 in. were found near the ends as shown in Figure 4.11.

Bars in the middle of the top mat (nos. 3-8) showed less damage due to vibration. However, several rough spots on the surface of the coating were found with the bare steel surface exposed.

The bottom mat bars showed a damage pattern similar to that of the top mat bars. Bars on the sides were subjected to more violent contact with the vibrator than the bars in the middle. Damaged spots measuring approximately 1/4 in. x 1/8 in. were observed especially near the corners. Typical damage found on these side bars is shown in Figure 4.12.

Table 4.1 Percentage of Damage Due to Vibration for the Column Base Specimen.

Top Mat #8 Bars Length-40" Surface Area-125in. <sup>2</sup>			
Number of Bar	Location of Bar	% of Damage	
Upper	1	Side	3.0
	3	Adjacent to Side	1.2
	5	Middle	0.6
	7	Adjacent to Side	0.9
	9	Side	0.6
Lower	2	Side	3.0
	4	Adjacent to Side	0.9
	6	Middle	0.4
	8	Adjacent to Side	1.1
	10	Side	1.5

Bottom Mat #4 Bars Length-40" Surface Area-62.8in. <sup>2</sup>			
Number of Bar	Location of Bar	% of Damage	
Upper	1	Side	1.4
	3	Adjacent to Side	0.5
	5	Middle	0.1
	7	Adjacent to Side	1.2
	9	Side	1.6
Lower	2	Side	1.2
	4	Adjacent to Side	0.5
	6	Middle	0.3
	8	Adjacent to Side	0.2
	10	Side	0.1

Vertical Bars Length-40" Surface Area-62.8in. <sup>2</sup>		
Number of Bar	Location of Bar	% of Damage
1	Side	1.9
2	Adjacent to Side	0.5
3	Middle	0.2
4	Adjacent to Side	0.9
5	Side	0.5



(a) Damage on the lugs

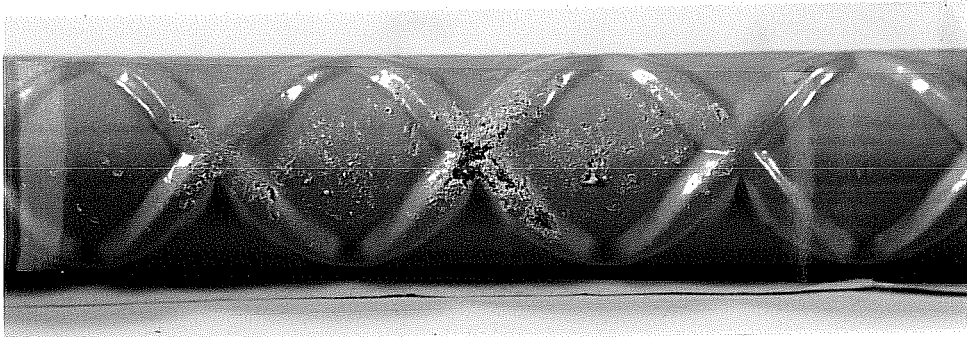

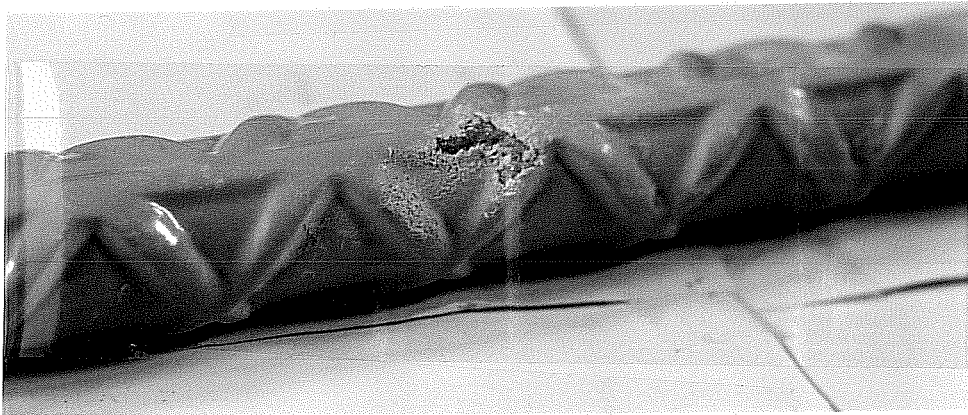
(b) Damage on the side rib

**Figure 4.11** Damage due to vibration on the top side bars in the column specimen.

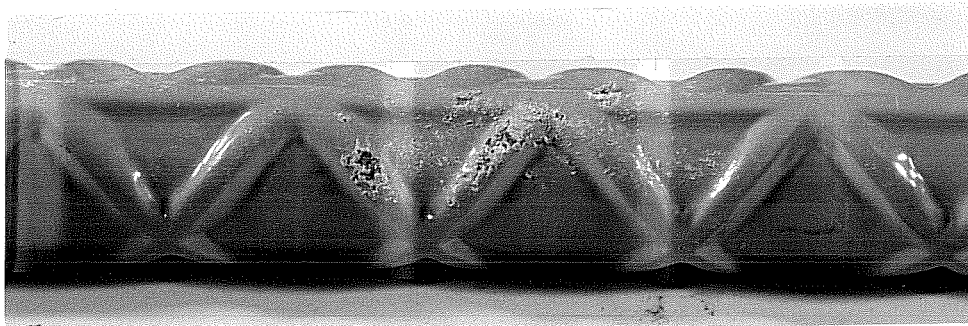

**Figure 4.12** Damage due to vibration on the bottom side bars in the column specimen.

**4.4.3 Slab Specimen With #4 Bars.** Similar to the column base specimen, damaged areas were easily identified by the rough surfaces of the coating caused by the vibrator. Isolated or inter-connected spots of variable sizes were found distributed along the bars. The majority of these spots had a size equal to or less than 1/16 in. x 1/16 in. Only a few damaged areas were relatively worrisome with the bare steel surface exposed. However, the largest spot did not exceed 1/4 in. x 1/4 in., which occurred at the end of one middle bar. Figure 4.13 shows some of the largest damaged areas of coating found in the specimen with #4 bars.

The total damaged area of the coating on each bar ranged from 0.1% to 1.1% of the bar surface area, whereas the maximum percentage of damage per linear foot ranged from 0.2% to 1.7%. Table 4.2 shows the percentages of damage (the total and the maximum per linear foot) for each bar. The distribution of total damage reveals no significant difference between the bars on the side and the bars in the middle. However, the most damaged lineal foot of each bar almost consistently occurred near the end, indicating that damage was more concentrated in the areas of limited spaces for vibration.

An important observation is that the average percentage of damage of the bars with cross deformations was almost three times that of the bars with parallel deformations. Although this is highly dependent on the operator who controls the movement of the vibrator, the bar deformation pattern may be a contributing factor. For most angles of attack of the vibrator head, a bar with cross deformations will have a larger area of the lugs per unit length exposed for contact with the vibrator. For this reason, bars with cross deformations may be damaged more than those with parallel deformations under similar conditions of vibration.

**4.4.4 Slab Specimen With #8 Bars.** Damaged spots on #8 bars were larger and more frequent than those on #4 bars. The largest spot was a little less than 1/2 in. x 1/4 in. (0.12 in.<sup>2</sup>) which occurred on one side bar with cross deformations. The side bars, in general, had the worst damage, especially near the ends. Figure 4.14 shows examples of the damage found on these side bars.

For this specimen, the total damaged area of the coating on each bar ranged from 0.3% to 1.7% of the bar surface area. The maximum percentage of damage per linear foot, however, ranged from 0.4% to 2.2%. Table 4.3 shows these percentages of damage in a similar manner to those percentages on #4 bars listed in Table 4.2. The distribution of total damage, in this case, clearly indicates that the side bars had, on average, three times the amount of damage found on the middle bars. Most of the damage was on the side bars with only 2 in. clearance.

The upper bars in the mat were, generally, more damaged than the lower bars. Damage on the bars with either type of deformation (the parallel or cross deformations) was not significantly different. In any case, the pattern of damage or roughening of coating surface was typical of that observed in the other two specimens.



Figure 4.13 Damage due to vibration on #4 bars – slab specimen.

Table 4.2 Percentage of Damage Due to Vibration for the Slab Specimen With #4 Bars.

Upper Bars Length-35 in. Surface Area-55 in. <sup>2</sup>		
Location of Bar	Total % of Damage	Max. % of Damage/Ft.
Side	0.9	1.7
Adjacent to side	0.5	0.7
Adjacent to side	0.2	0.3
Side	0.1	0.2
Lower Bars Length-22 in. Surface Area-35.6in. <sup>2</sup>		
Location of Bar	Total % of Damage	Max. % of Damage/Ft.
Side	0.8	1.1
Adjacent to side	1.1	1.4
Middle	0.9	1.1
Middle	0.5	0.6
Adjacent to side	0.6	0.7
Side	0.3	0.3

Table 4.3 Percentage of Damage Due to Vibration for the Slab Specimen With #8 Bars.

Upper Bars Length-35 in. Surface Area-110 in. <sup>2</sup>		
Location of Bar	Total % of Damage	Max. % of Damage/Ft.
Side	1.6	2.1
Adjacent to Side	0.3	0.4
Adjacent to Side	0.5	0.8
Side	1.7	2.2
Lower Bars Length-22 in. Surface Area-69.1in. <sup>2</sup>		
Location of Bar	Total % of Damage	Max. % of Damage/Ft.
Side	0.6	0.9
Adjacent to Side	0.3	0.4
Adjacent to Side	0.4	0.5
Side	1.0	1.6

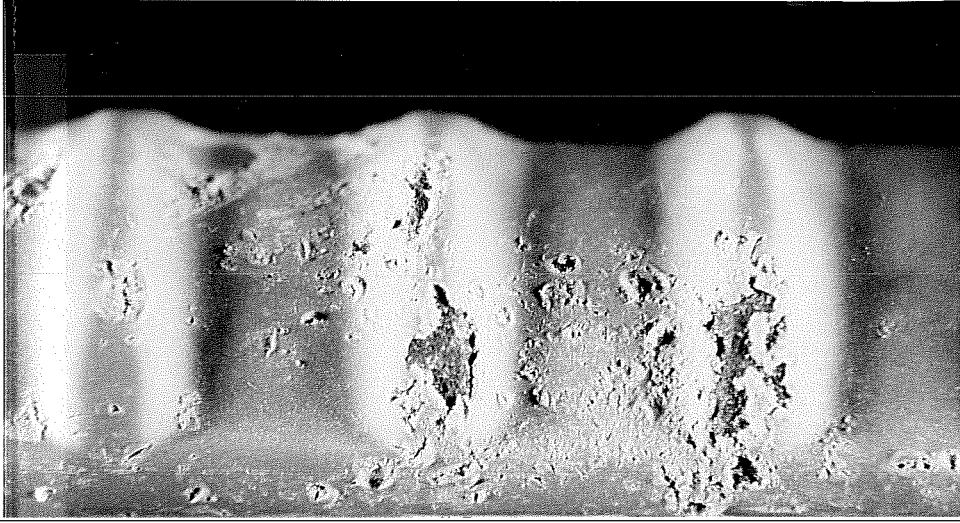

## 4.5 Discussion of Results

The three specimens consistently showed that vibration of concrete during placement can produce considerable damage to coated reinforcing bars. Typical damage due to vibration consisted of abrasion and roughening of the surface of the coating. Damage was generally limited to the lugs, as they were the most likely part of the bar to come in contact with the vibrator. Where space for motion of the vibrator was limited, damage was the worst as indicated by damage concentrated near the ends on the side bars at form corners.

The total damaged area of the coating on each bar in the three specimens ranged from 0.1% to 3.0% of the bar surface area. According to ASTM D3963 specification, bars with a damaged area larger than 2% of the total surface area per linear foot and damage spots with a size greater than 1/4 in. x 1/4 in. should be repaired. In the tests performed damage to some of the bars was greater than 2% of the total surface area and some bars had damage spots exceeding the size limit.

Different bar sizes have different surface curvature which results in unequal contact areas between the bar and the vibrator head. Larger size bars have more contact areas and, therefore, more chances of locking small aggregate particles in between the two colliding surfaces than small size bars. Therefore, #8 bars are more susceptible to damage due to vibration than #4 bars. The smaller size bars, in the three specimens, did not show damage that exceeded both the 2% limit and the spot size limit. Damage to some #8 bars, on the other hand, exceeded both limits. In addition, the side bars tend to be worse than the middle bars for the larger size bars, especially where the side clearance is limited to 2 in. However, damage on cross deformations, when compared to that on parallel deformations, seems to be more on smaller size bars. The largest damaged spots in the three tests occurred on bars with cross deformations. Since the database is quite small, more tests may be needed if the effects are to be quantified.

The important conclusion is that even if the bars were carefully handled and all visible damage was patched before placing, the bars might still be subjected to considerable damage during concrete placement. Therefore, damage due to vibration should not be ignored. Damage of this sort cannot be repaired and can have a detrimental effect on the performance of epoxy-coated reinforcement. It is reasonable to expect that the most damaged bars will be those near the surface of the concrete. Techniques for improving vibrating practice should be adopted to reduce damage that can not be repaired. Some equipment suppliers are proposing the use of "soft" vibrator heads for use with epoxy-coated reinforcement, but such equipment was not evaluated in this study.

It is believed that damage due to vibration can be reduced if precautions are taken. By following standard operating procedures and using common sense, damage can be effectively minimized. The vibrator should be lifted up and down to avoid dragging the vibrator head over bars, which causes damage. Special care should be taken when the vibrator is used in a confined space to avoid violent contact between the vibrator and the bars. Finally, the use of vibrators with plastic "soft" heads may be desirable. It was seen from the experience with

bending operations that plastic rings greatly reduced damage on the inside of the bends, and it may be possible to obtain similar results with nonmetallic vibrator heads. However, it is recommended that the pros and cons of the newly-introduced "soft" vibrator heads be investigated before implementation to determine whether they actually prevent damage and still produce well-consolidated concrete.

## **CHAPTER 5**

### **HOT WATER IMMERSION TEST**

#### **5.1 Introduction**

The application of epoxy-coated reinforcing bars in the United States has drawn the attention of many European countries like Germany, Denmark, the Netherlands, and Switzerland. In search of an effective quality control test, one European country has introduced the hot water immersion test. The quality of the coating application in this test is checked by placing coated bar specimens (straight or bent) in a hot water bath having a temperature of approximately 80° C for seven days.<sup>13</sup> The visual appearance of the bars at the end of this period indicates whether coating application was successful or not.

According to the visual acceptance criteria of this test in Swiss guidelines, a successful coating application should meet the following requirements: (1) in previously undamaged areas, no deterioration is acceptable (inspection by microscope); and (2) in patched areas, deterioration such as the formation of blisters and damage visible to the unaided eye is acceptable. The use of this test in Europe deserves serious consideration for adoption in the United States. One objective of this study is to find better ways to control coating quality, and to meet this objective a hot water immersion test was conducted for a limited number of bar specimens.

In the previously mentioned immersion test of bent bars, a 3.5% NaCl solution was used to create a corrosive environment. The aim of that test was to investigate the performance of coated bars under such adverse exposure conditions. Defects in the coating, however, may be better detected when coated bars are immersed in hot water. The hot water bath test can, then, be used as a quick indicator of coating application quality. The simplicity and short period of immersion required favor this test for rapid quality evaluation.

#### **5.2 Test Setup and Procedures**

In this test, six bent bars (four #4s and two #8s) identical to those used in the saltwater immersion test were placed in hot water. Each bar was deliberately damaged with the introduction of two 1/4 in. x 1/4 in. damaged areas. One of the damaged areas was patched with the same material used at the coating plant, while the other area was left with the steel exposed.

All bars were immersed for a week. The water temperature was maintained at 80° C by a circulation heater connected to a preset temperature scale (see Figure 5.1). The immersion tank was a 5-gal. plastic bucket.



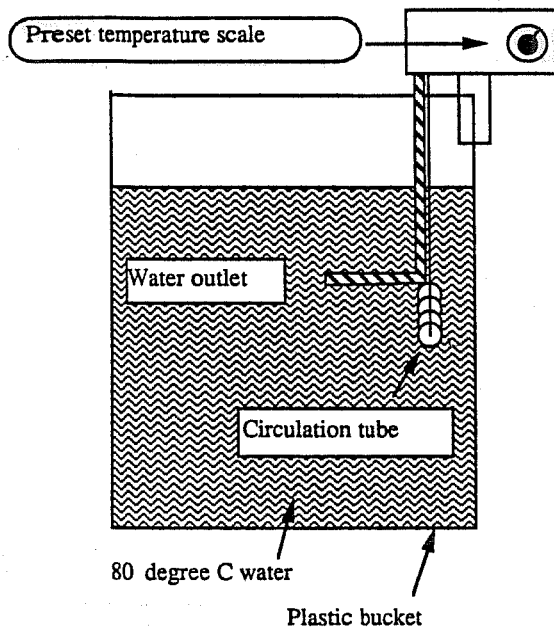

Figure 5.1 Schematic setup of the hot water immersion test.

### 5.3 Test Results

**5.3.1 #4 Bars.** Before immersion, numerous hairline cracks were observed on #4 bars with parallel deformations. Results from the immersion test in saltwater indicated corrosion at the cracks. In a similar fashion, the hot water immersion test showed deterioration at the cracks and the exposed damaged areas on both the inside and outside of bends (see Figure 5.2). Areas free from visible damage before immersion, and areas patched did not deteriorate during the test.

On #4 bars with cross deformations, no hairline cracks were observed initially, but holiday damage was evident after testing as indicated by rust build-up at the holidays (see Figure 5.3). This is consistent with the results of the saltwater immersion test where bars with cross deformations were found to be more susceptible to holiday damage. Damaged areas with exposed steel deteriorated during this test as expected, but patched areas did not.

**5.3.2 #8 Bars.** No visible signs of deterioration were observed on any #8 bar where the damaged area was patched. However, damage on a few holidays was evident especially on bars with cross deformations. In addition, a considerable amount of rust was seen on the exposed steel areas (see Figures 5.4 and 5.5). Minor deterioration occurred on the damaged areas on the inside of bends.

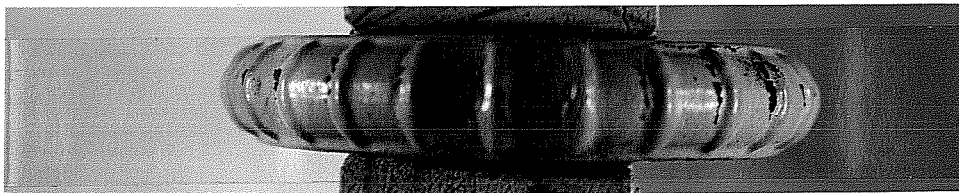
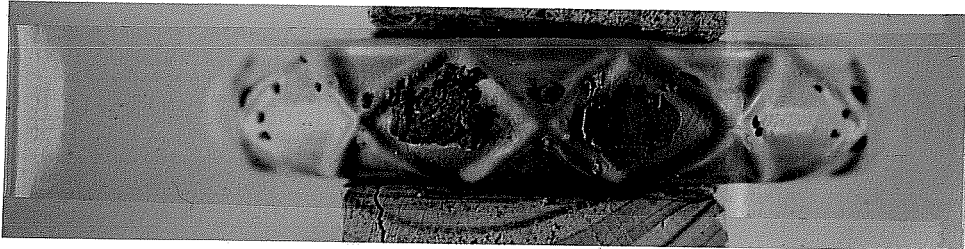
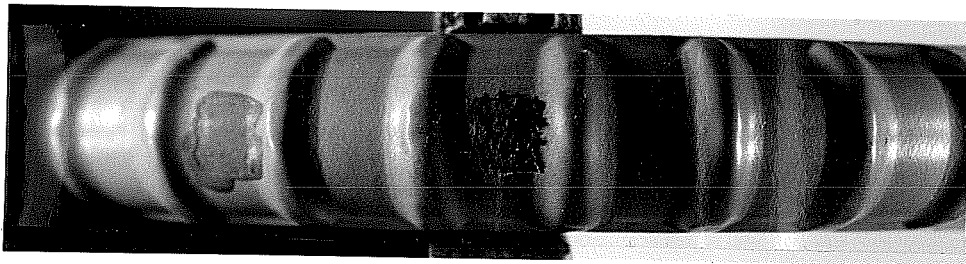

Figure 5.2 Deterioration of exposed areas on #4 bar with parallel deformations.



**Figure 5.3 Deterioration of exposed areas and holidays on #4 bar with cross deformations.**



**Figure 5.4 Deterioration of exposed areas on #8 bar with parallel deformations.**

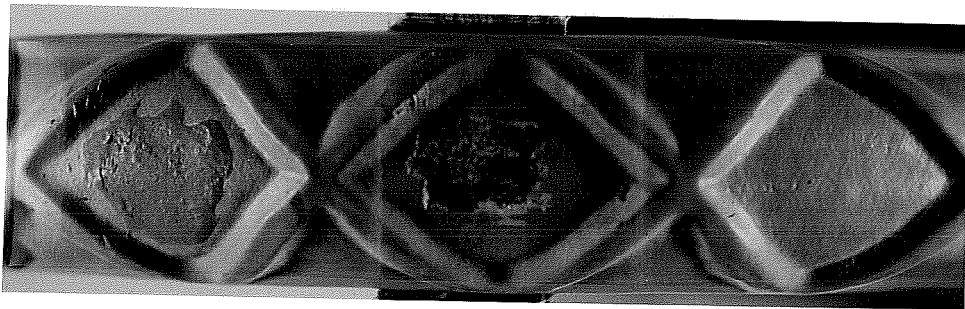

**Figure 5.5 Deterioration of exposed areas on #8 bar with cross deformations.**

#### **5.4 Discussion of Results**

Based on the above observations, it is clear that all of the tested bars did not satisfy the requirements of the hot water immersion test. The quality of coating application was not satisfactory because of the deterioration that appeared on pinholes and cracks in previously undamaged areas. Integrity of coating was not maintained, especially along the sides of the lugs.

It is worth mentioning in this context that the hot water test is one out of 16 different tests in the Swiss guidelines for coating quality control. The application of these tests altogether is meant to assure a high quality level in the coating system. The tests virtually supplement each other by putting various constraints on the end product. With regard to bending of rebars, for example, the Swiss guidelines require that a visual inspection of the coating does not show any signs of deterioration or damage in the curved area. This requirement would immediately cause the rejection of any bars with cracks or damaged spots anywhere on the inside or outside of bends produced by bending to certain mandrel diameters.

In conclusion, the hot water immersion test for coated bars (straight or bent) seems to provide an objective indication of the quality of coating application. The test was especially effective in identifying pinholes in the coating on bent bars. The convenience of this short test and its reliability indicate that further development should be undertaken to produce a coating quality control test.

## **CHAPTER 6**

### **CONCLUSIONS AND RECOMMENDATIONS**

#### **6.1 Introduction**

The objectives of this study were the evaluation of the various sources and consequences of damage to epoxy-coated reinforcement. For inspection of damage before placement, holiday detectors were evaluated. Potential damage resulting from concreting operations such as placement and consolidation was investigated. To examine the quality of the coating following application, a hot water bath test was evaluated. Finally, performance of the epoxy-coated reinforcement was evaluated by cyclic immersion of bars with different damage levels in a saltwater solution. Results of the immersion test are based on observations of the bars for a period of 240 days of immersion.

#### **6.2 Conclusions**

The following conclusions can be drawn from the observations and discussion:

- 1) Holiday detectors cannot be considered as reliable devices to monitor coating defects. Satisfactory, repeatable readings for the same test condition could not be achieved.
- 2) Even the smallest damage in the coating will initiate corrosion in a severe environment. The damage includes hairline cracks, small pinholes (holidays), and any weakness in the coating.
- 3) Repair practice (patching) proved to be ineffective. All the patched areas on the bars started to deteriorate after a few weeks of immersion testing.
- 4) Bars with more complicated patterns had more coating defects. The sides of the deformation lugs are difficult to coat uniformly and tend to have more coating defects.
- 5) Small-size bars exhibited more hairline cracking in the coating when bent to a smaller radius than large-size bars. Tight bending radii cause more stretching of the coating that may result in damage.
- 6) Vibration equipment used during concrete placement may introduce considerable damage to the coating. Some of the damage was so severe that it exceeded the limit at which repair is required before the bars can be placed in the forms. There was greater damage with larger size bars and with small clearances between bars and the forms.

### 6.3 Recommendations

Successful application of epoxy-coated reinforcing bars relies on high-quality products and a complete quality control system throughout construction. Based on the tests conducted in this study, the following recommendations are presented.

- 1) A more reliable defect-monitoring system should be developed. The detectors currently used need to be modified to increase their reliability. An inspector using a hand-held type of holiday detector should conduct tests using different orientations of the detector and visual inspection is needed to obtain reliable results.
- 2) Bending operations cause considerable damage at the contact areas between the coated bar and the bending equipment. It was found that by using plastic rings over the mandrels, damage was greatly reduced. Protective materials should be used at contact points when epoxy-coated bars are fabricated.
- 3) Bending epoxy-coated bars to minimum radii allowed in design may cause hairline cracking on the outside of the bend. Tight bending radii should be avoided unless required for structural purposes.
- 4) Standard repair practices for coating damage seems ineffective when the bars are in a severe corrosive environment. Coating on patched areas does not perform as well as fusion-bonded coating. A better repair procedure should be investigated.
- 5) Damage to coating occurs when internal vibrators are used during the concrete placement process. Careful operation of vibrators can reduce this kind of damage. Vibrators with "soft" surfaces should be investigated to determine their performance, especially in regard to coating damage.

To achieve better performance with epoxy-coated reinforcing bars, a quality control system applied at all stages of the fabrication and construction process should be established by the applicator, the fabricator, the contractor, and the owner. A thorough understanding of the processes involved during each stage should be required of all parties involved.

## REFERENCES

1. Zayed, A., Sagues, A., and Powers, R., "Corrosion of Epoxy-Coated Reinforcing Steel in Concrete," *Corrosion/89*, Paper No. 379, National Association of Corrosion Engineers, Houston, 1989.
2. Sagues, A., and Powers, R., "Effect of Concrete Environment on the Corrosion Performance of Epoxy-Coated Reinforcing Steel," *Corrosion/90*, Paper No. 311, National Association of Corrosion Engineers, Houston, 1990.
3. "Holiday Detection of Fusion-Bonded Epoxy External Pipeline Coating of 10 to 30 Mils (0.25 to 0.76 mm)," NACE Standard RP0490-90, Item No. 53074.
4. Sagues, A., "Evaluation of Corrosion Rate by Electrochemical Impedance in a System with Multiple Polarization Effects," *Corrosion/89*, Paper No. 25, National Association of Corrosion Engineers, Houston, 1989.
5. "Maintenance and Rehabilitation Considerations for Corrosion Control of Existing Steel Reinforced Concrete Structures," NACE Standard RP0390-90, Item No. 53073.
6. "Guidelines for Inspection and Acceptance of Epoxy-Coated Reinforcing Bars at the Job Site," 1st Ed., Concrete Reinforcing Steel Institute, Schaumburg, Illinois, 1986.
7. Zayed, A., and Sagues, A., "Corrosion at Surface Damage on an Epoxy-Coated Reinforced Steel," *Corrosion Science*, Vol. 30, No. 10, 1990, pp. 1025-1044.
8. "Voluntary Certification Program for Fusion Bonded Epoxy Coating Applicator Plants," 1st Ed., Concrete Reinforcing Steel Institute, Schaumburg, Illinois, 1991.
9. Sohaghpurwala, A.A., and Clear, K.C., "Effectiveness of Epoxy Coatings on Minimizing Corrosion of Reinforcing Steel in Concrete," Paper No. 890432, *Transportation Research Board*, 69th Annual Meeting, Washington, D.C., January 1990.
10. Fontata, M.G., "Corrosion Engineering," 3rd Ed., McGraw-Hill, Inc., New York, N.Y., 1986.
11. "Standard Specification for Epoxy-Coated Reinforcing Steel Bars," ASTM Standards, D3963/D3963M-87.
12. "Standard Specification for Epoxy-Coated Reinforcing Steel Bars," ASTM Standards, A775/A775M-90.

13. "Epoxy-Coated Rebars—Swiss Guidelines," Peter Matt, private communications, February 1992.
14. Treadaway, K.W.J., and Davies, H., "Performance of Fusion-Bonded Epoxy-Coated Steel Reinforcement," *The Structural Engineer*, V. 67, No. 6/21, March 1989, pp. 99-108.
15. "SSPC-SP10 Near White Blast Cleaning," SSPC Standards.
16. "Surface Preparation: The State of the Art," SSPC Standards, 1985.
17. "Discontinuity (Holiday) Testing of Protective Coatings," NACE Standard Recommended Practice, RP0188-88.
18. Mindess, S., and Young, J.F., "Concrete," Prentice-Hall, 1981.
19. Clear, K.C., and Virmani, Y., "Corrosion of Nonspecification Epoxy-Coated Rebars in Salty Concrete," *Public Roads*, Vol. 47, p. 1, 1983.

**1 B.3**

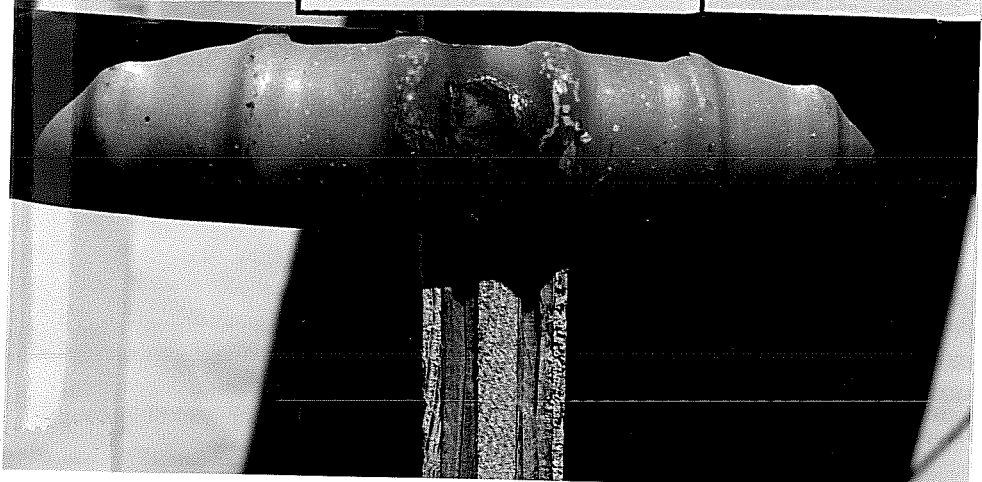

*delete* →

*loop*

*u*

Diamond deformation

**3 B.9**

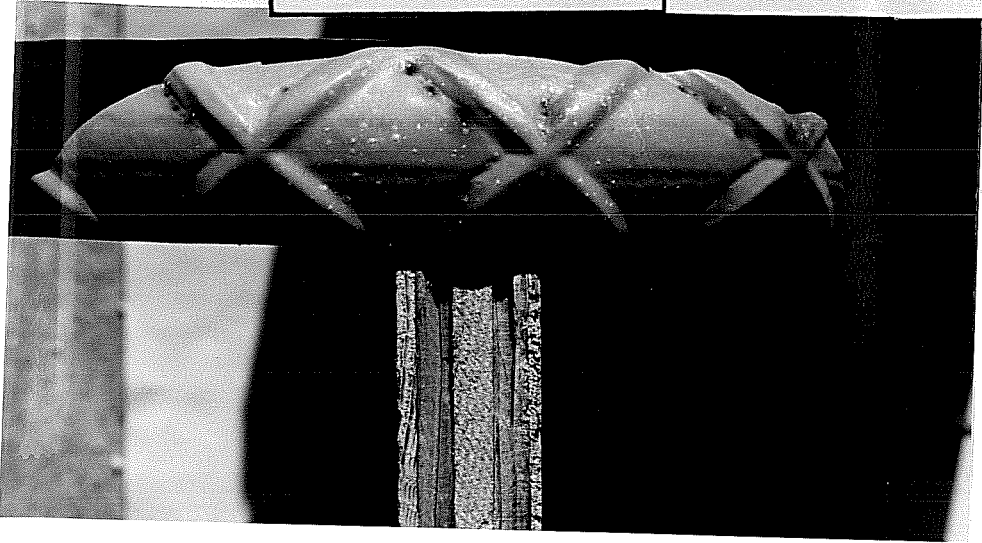

*delete* →

*u*

*u*

Bamboo deformation

Figure 3.4-6 Comparison of corrosion on holidays



more to  
68 ←

Fig 3.11(b) →

je

je

je

je

Bars with diamond deformations



delicate →

Bars with bamboo deformations

Figure 3.4-8 Comparison of corrosion on hairline cracks

delete →

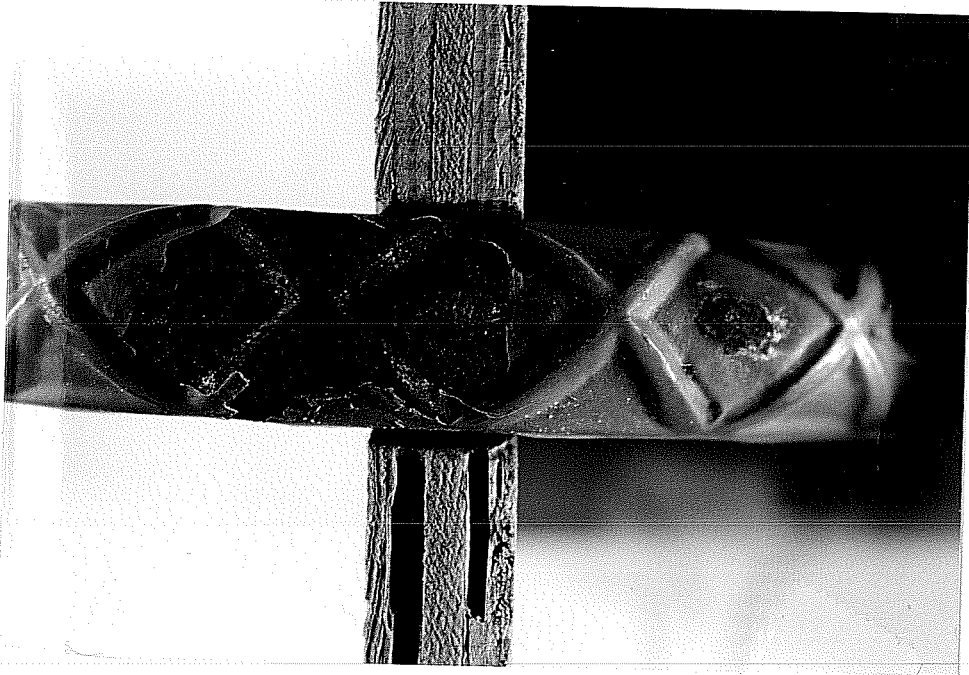

10

10

3.16(b)

10

10

Figure 3.5-2 Penetration of corrosion

*delete* →

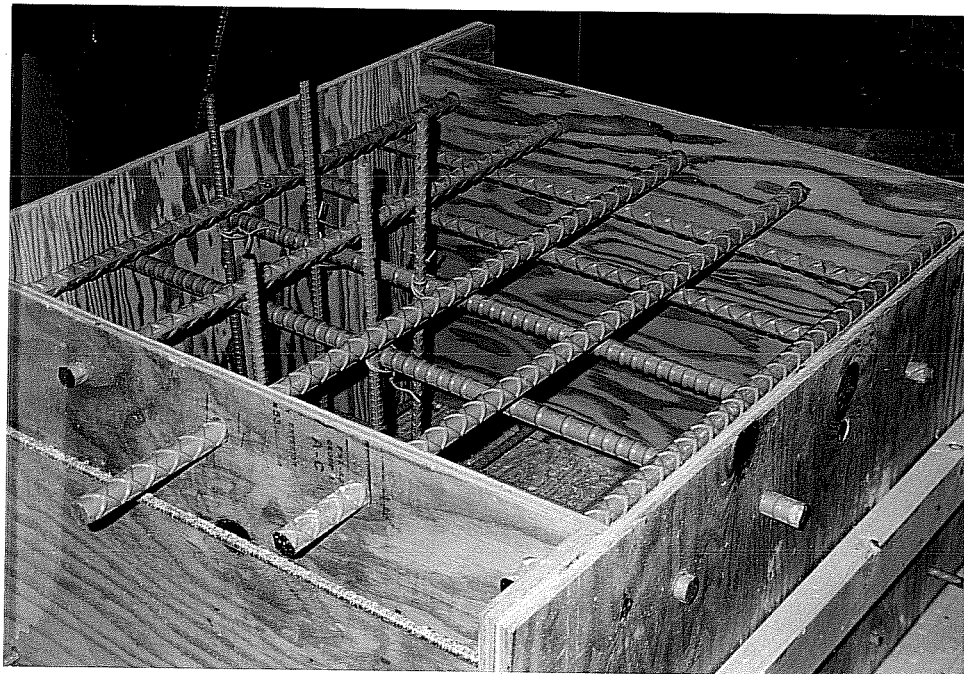

*H. 2*

Figure 4.2-2 Arrangement of vertical bars

*delete* →

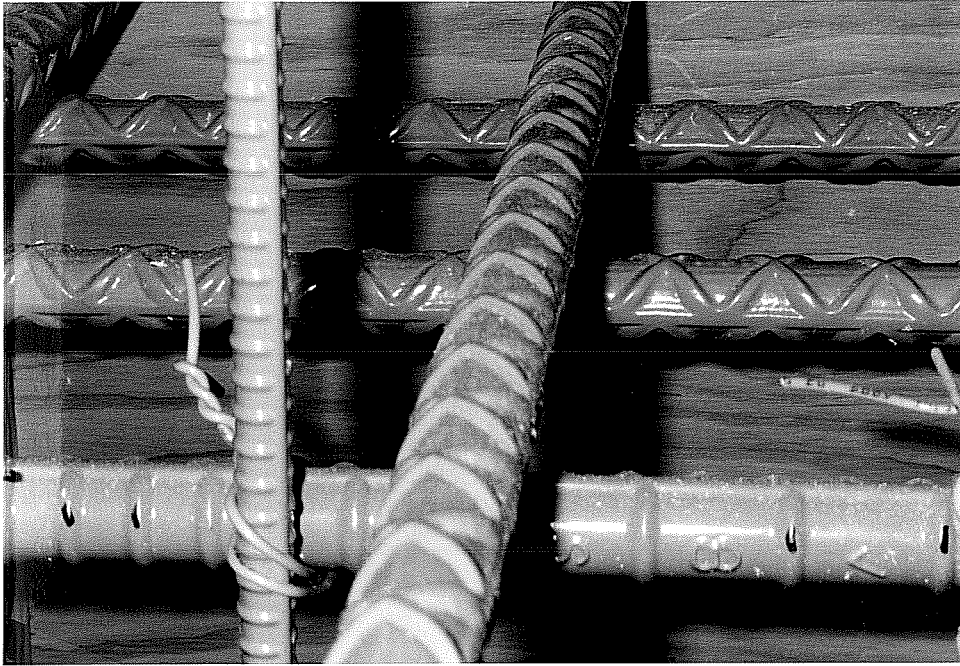

4.3

Figure 4.2-3 Connection of vertical bars using plastic wires

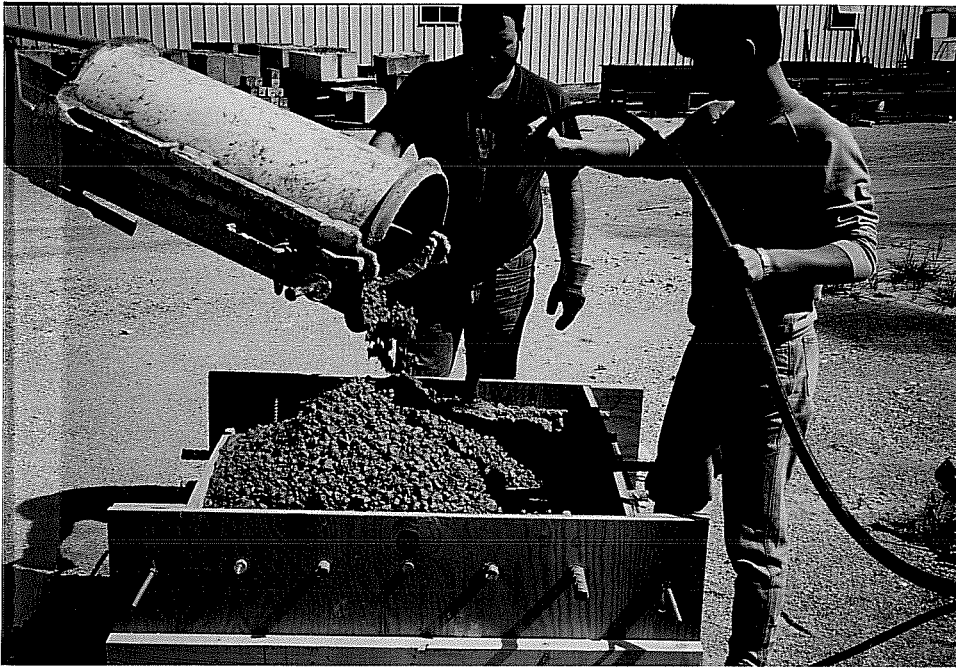

*delite*

*4.8*

Figure 4.3-1 Operation process during placement



delete  
→

1c

1c

1c

1c

4.12

Figure 4.4-2 General damage patterns due to vibration

*delute* →

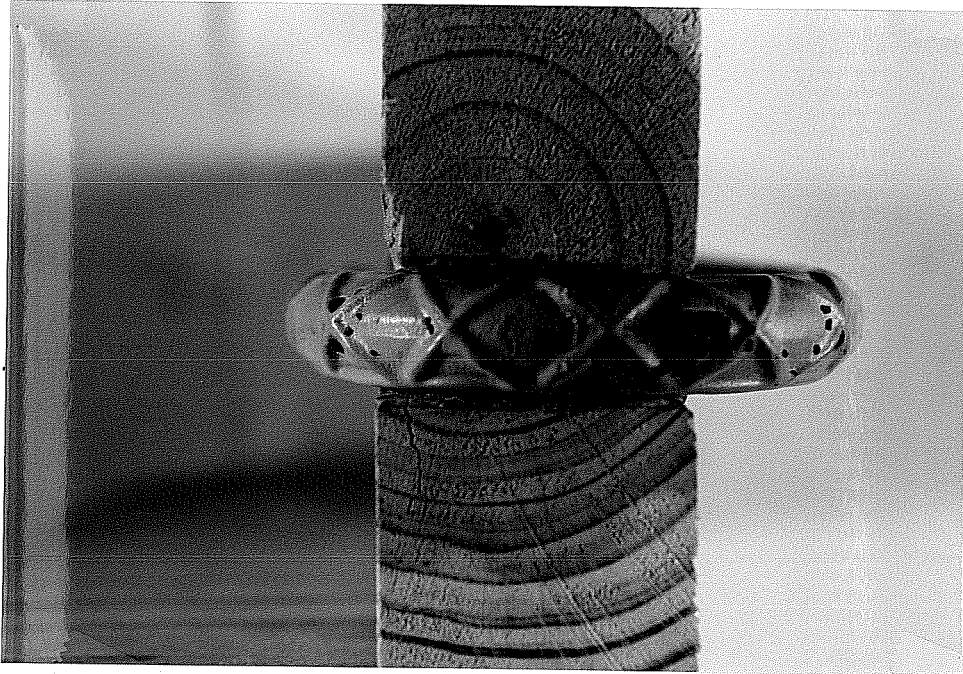

) c  
c

*delute* →

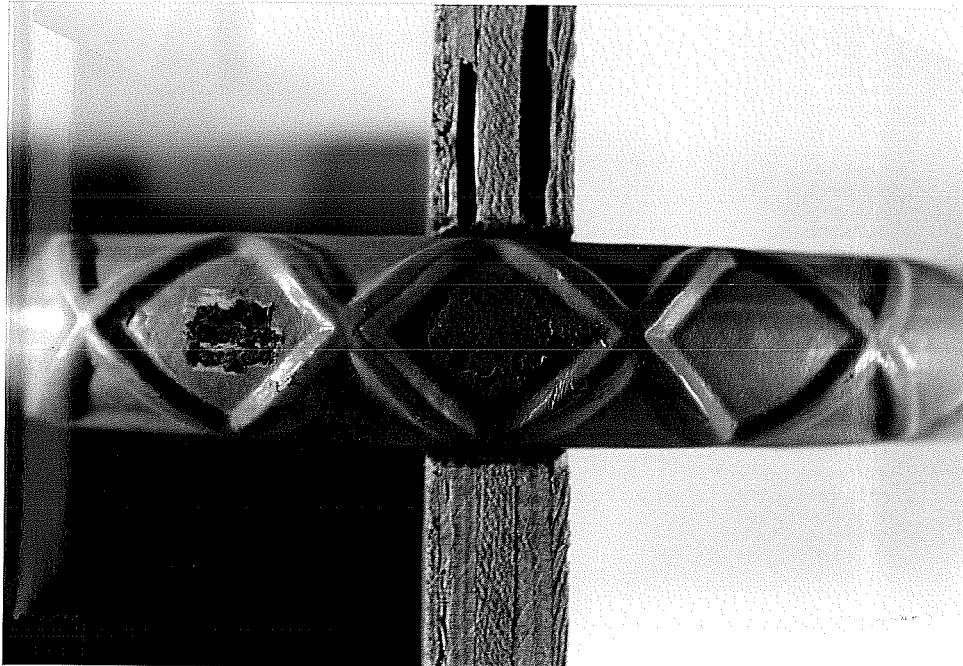

) c  
c

Figure 5.3-3 Deterioration on introduced damage

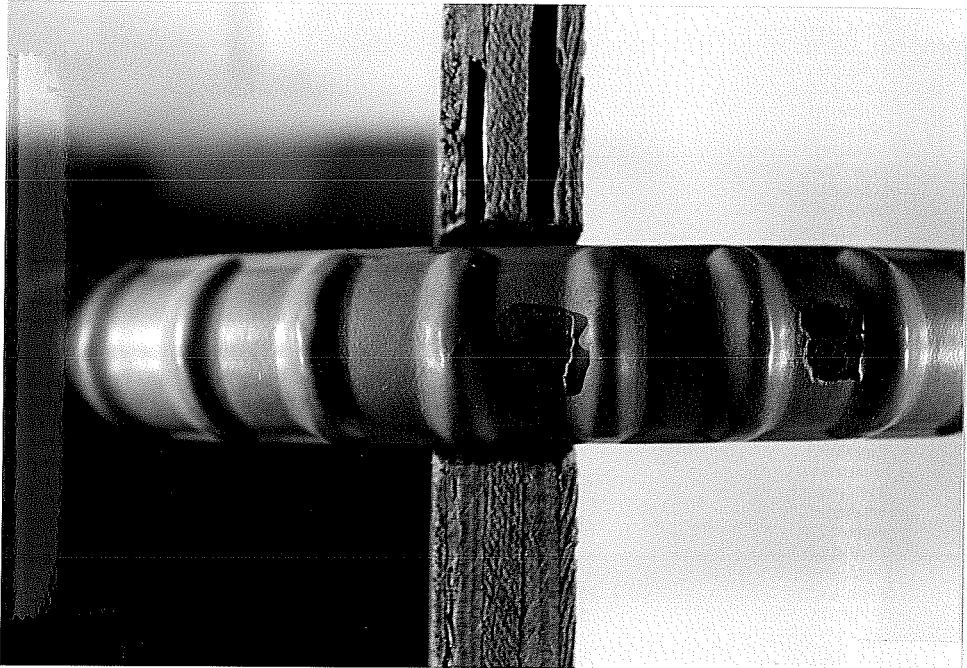

*delete*

*70*

*70*

#4 bar

*5.2*

*70*

*70*

#8 bar

Figure 5.3-4 Deterioration on patched areas